

LESSO

CHINA LESSO GROUP HOLDINGS LIMITED

(Hong Kong Listed Stock Code: 2128)
www.lesso.com

LESSO[®] America



LESSO AMERICA, INC.

Headquarter
LESSO AMERICA INC.
1010 Railroad Street Corona, CA 92882
Main: (951) 547-6888
Toll Free: (888) 988-8839
Fax: (951) 547-6886

LESSO Texas Warehouse
3102 Miller Park South Suite #300 Garland, TX 75042
Main: (972) 272-1888
Warehouse: (972) 272-0113
Fax: (972) 494-7064

www.lessoamerica.com

LESSO Michigan Warehouse
2075 W Beecher, Adrian MI 49221
Main: (517) 662-3230
Secondary: (517) 662-3235
Fax: (517) 662-3233

LESSO Florida Warehouse
CROSSROAD DISTRIBUTION CENTER
1091 Gills Drive, Building C, Suite #100,
Orlando, Florida 32824
Main: (407) 852-9100

* LESSO America is affiliated with China LESSO Group Holdings Limited.

* This catalog has been prepared as a support guide. Under no circumstance shall LESSO America assume any liability or responsibility with the information in this catalog. Every effort has been made by LESSO America to provide accurate and up to date information.

All Rights Reserved. Printed in China Jul. 2019 (HC)

LESSO AMERICA, INC. PIPE FITTINGS CATALOG



LESSO AMERICA, INC.

PIPE FITTINGS CATALOG

Jul. 2019

Jul.2019

CONTENTS

- 01-02 **LESSO GROUP PROFILE**
- 03-04 **LESSO AMERICA, INC.
COMPANY PROFILE**
- 05-19 PVC Schedule 40 Fittings
- 20-23 PVC UVR Sch40 Fittings
- 24-30 PVC Schedule 80 Fittings
- 31-47 PVC DWV Fittings
- 48-59 ABS DWV Fittings
- 60-64 American Certifications
- 65 Limited Warranty
- 66 Terms and Conditions of Sale

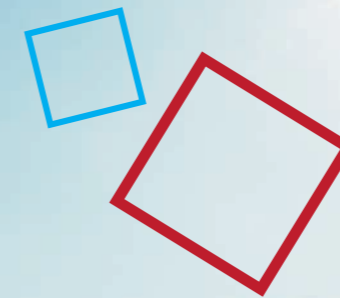

GUARANTEED QUALITY, TRUSTWORTHY CHOICE



GROUP PROFILE



LESSO Research Institute & Testing Center

LESSO College

Training Apartment

LESSO HOME

China LESSO Group Holdings Limited

China Lesso Group Holdings Limited (Stock Name: China Lesso, Stock Code: 02128.HK) is a large industrial group of home furnishings and building materials in China. China Lesso's product portfolio spans piping, sanitary ware, integral kitchen, integral doors and windows, decorative plates, water purifiers, fire-fighting equipment, valves, hygiene materials, oceanic aquaculture cages, products for environmental protection, home furnishings and building materials, channels and services, and more. Its sales revenue has reached RMB 23.734 billion in 2018.

With the rapid development of internationalization and globalization, China Lesso boasts more than 80 holding subsidiaries and more than 23 production bases distributed in 17 provinces across China, and in US, Canada, India, Indonesia and Uganda. China Lesso remains committed to improving its strategic layout, broadening its sales network and expanding the market. This is how it provides products and services for customers in a timely and efficient way.

China Lesso has established an international R&D center with more than 1,000 scientific researchers. The Group now boasts eight national high-tech enterprises, one national accredited enterprise technology center, two post-doctoral workstations, six China national accredited laboratories authorized by CNAS, one academician workstation, one key enterprise laboratory of plastics molding and processing technology in Guangdong Province, and the Union of Technical Innovation of Plastic Pipe Industry in Guangdong Province.

China Lesso owns about 1,480 patents (some of them are pending). Some of Lesso's scientific achievements are included in National Torch Plan Projects, National Key New Product, Scientific Achievements Promotion Projects in National Construction Industry and Government Green Procurement List. The Group has been awarded many honorary titles and prizes, such as National High-Tech Enterprise, National Certified Enterprise Technology Center, China Construction Independent Innovation of Science Superior Enterprise, Intellectual Property Right Preponderant Enterprise, Demonstrational Construction Base of Plastic Piping High Tech Industrialization of Ministry of Urban and Rural Development, Guangdong Provincial Government Quality Prize, and the First Prize of Scientific and Technological Progress in Guangdong Province.

As a domestic manufacturer of extensive home furnishings and building materials, China Lesso offers over 10,000 kinds of products. Its products are being widely used in many areas, including home decoration, civil construction, municipal water supply, drainage, power supply and telecommunications, gas supply, fire-fighting, environmental protection, agriculture and oceanic aquaculture.

True to its mission of "Creating a Relaxing Life", China Lesso will present a brand new image and offer more high cost-effective products and services to customers so that they can enjoy a comfortable and quality life.

COMPANY PROFILE



LESSO AMERICA, INC.

Based in Corona, CA, LESSO America, Inc. is a wholly owned subsidiary of China Lesso Group Holdings Limited. LESSO America absorbed decades of field experience in the plumbing and irrigation field from its listed parent, a leading player in the field.

To sustain its flawless plastic injection-molded product line and sales network, Lesso America manufactures and delivers high-quality plastic fittings with the latest injection mold tools and technology through distribution centers from coast to coast. With 100% dedication and commitment, LESSO America is leveraging the inherited success of its mother company's model to provide an outstanding customer experience for our clients.

Quality

Lesso America's plastic fittings line is renowned worldwide for its superior quality, which complies with cNSFus, CSA and cUPC certifications, and exceeds the requirements of ASTM standards.

Independent Research And Development, Keep Step With The World



International Certifications



PVC Schedule 40 Fittings

QUALITY

LESSO America's plastic fittings line is renowned worldwide for its superior quality, which complies with cNSFus and cUPC certifications, and exceeds the requirements of ASTM standards and CSA standards.

REFERENTIAL STANDARDS

NSF/ANSI 61 Drinking Water System Components - Health Effects

NSF/ANSI 14 Plastics Piping System Components and Related Materials

ASTM D 1784 Standard Specification for Rigid Poly(Vinyl Chloride) (PVC) Compounds and Chlorinated Poly(Vinyl Chloride) (CPVC) Compounds

ASTM D 2466 Standard Specification for Poly(Vinyl Chloride) (PVC) Plastic Pipe Fittings, Schedule 40

CSA B137.3 Rigid Polyvinylchloride (PVC) Pipe and Fittings for Pressure Applications



COLUMN HEADER INFORMATION

Each product column header label identifies the following product particulars:

Part Number: the number used to order the part.

Size: nominal diameter of pipe with which the fitting is to be used.

NOTE: Fittings may be same size (only one size designation) or reducing (multiple sizes designated).

Standard Pack (Std Pk) the quantity of parts packaged in an individual box or bag.

Master Carton (Mstr Ctn) the total quantity of parts contained in individual boxes or bags which are packaged together.

METHODS OF DESIGNATING INLETS OF FITTINGS

PVC SCHEDULE 40 FITTINGS

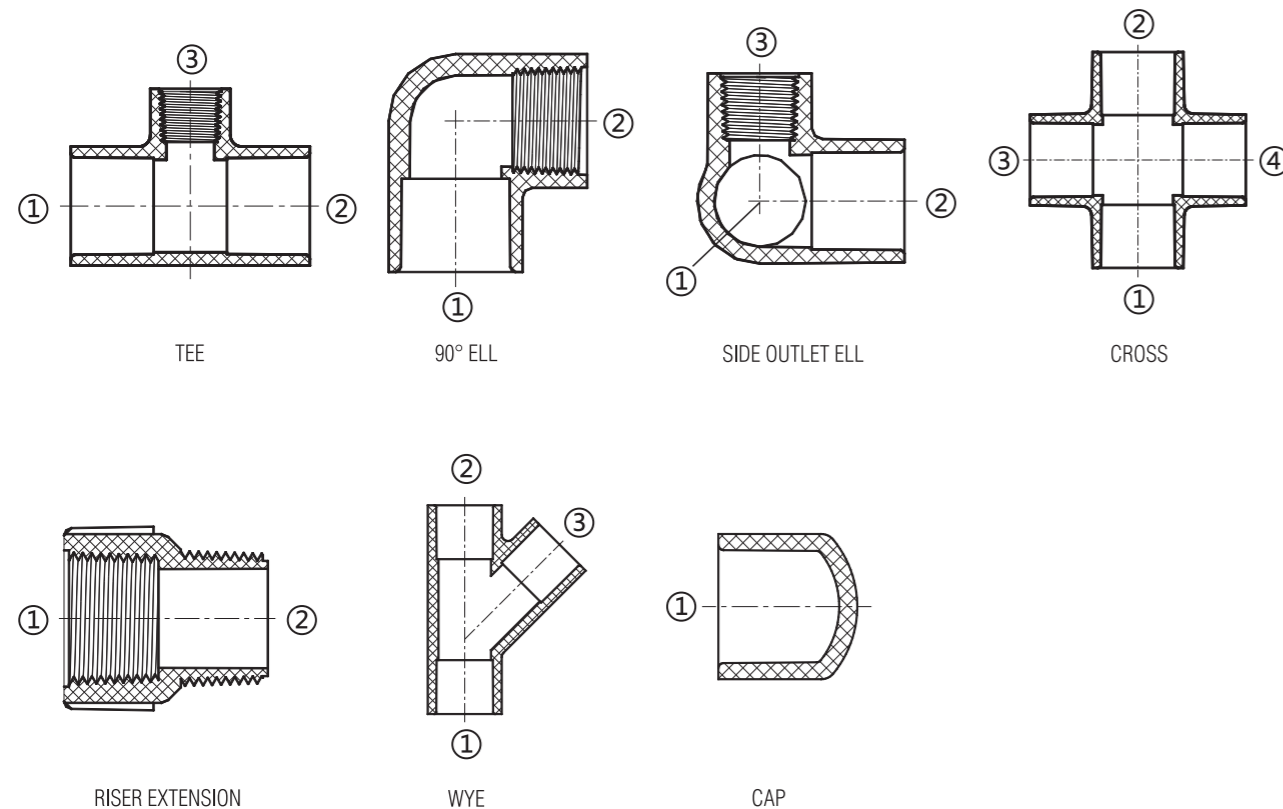

PVC SCHEDULE 40 FITTINGS



REDUCING TEE (SOC×SOC×SOC)

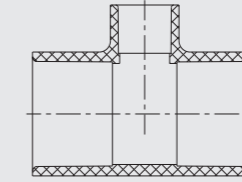

Part Number	Size (in)	Std PK	Mstr Ctn	Part Number	Size (in)	Std PK	Mstr Ctn
401-053	3/8x3/8x1/2	50	400	401-241	2x1-1/2x1-1/2	10	60
401-074	1/2x1/2x3/4	50	200	401-247	2x2x1/2	10	40
401-075	1/2x1/2x1	50	200	401-248	2x2x3/4	10	40
401-094	3/4x1/2x1/2	50	200	401-249	2x2x1	10	60
401-095	3/4x1/2x3/4	50	300	401-250	2x2x1-1/4	10	60
401-101	3/4x3/4x1/2	50	200	401-251	2x2x1-1/2	10	40
401-102	3/4x3/4x1	50	200	401-287	2-1/2x2-1/2x1/2	10	40
401-122	1x1/2x1	50	200	401-288	2-1/2x2-1/2x3/4	10	40
401-124	1x3/4x1/2	50	300	401-289	2-1/2x2-1/2x1	10	40
401-125	1x3/4x3/4	50	200	401-290	2-1/2x2-1/2x1-1/4	10	40
401-126	1x3/4x1	50	200	401-291	2-1/2x2-1/2x1-1/2	10	40
401-130	1x1x1/2	50	200	401-292	2-1/2x2-1/2x2	8	32
401-131	1x1x3/4	50	200	401-333	3x3x1/2	8	32
401-132	1x1x1-1/4	25	150	401-334	3x3x3/4	10	0
401-133	1x1x1-1/2	25	100	401-335	3x3x1	10	0
401-134	1x1x2	25	100	401-336	3x3x1-1/4	8	32
401-156	1-1/4x1x1/2	25	150	401-337	3x3x1-1/2	15	0
401-157	1-1/4x1x3/4	25	150	401-338	3x3x2	6	24
401-158	1-1/4x1x1	25	150	401-339	3x3x2-1/2	10	0
401-166	1-1/4x1-1/4x1/2	25	150	401-416	4x4x3/4	6	24
401-167	1-1/4x1-1/4x3/4	25	100	401-417	4x4x1	6	24
401-168	1-1/4x1-1/4x1	25	100				
401-169	1-1/4x1-1/4x1-1/2	25	100				
401-199	1-1/2x1-1/4x1/2	25	150				
401-201	1-1/2x1-1/4x3/4	25	150				
401-202	1-1/2x1-1/4x1	25	100				
401-203	1-1/2x1-1/4x1-1/4	25	100				
401-209	1-1/2x1-1/2x1/2	25	100				
401-210	1-1/2x1-1/2x3/4	25	100				
401-211	1-1/2x1-1/2x1	25	100				
401-212	1-1/2x1-1/2x1-1/4	25	100				
401-213	1-1/2x1-1/2x2	10	60				
401-233	2x1x2	10	40				
401-238	2x1-1/2x3/4	10	40				
401-239	2x1-1/2x1	10	60				

PVC SCHEDULE 40 FITTINGS



TEE (SOC×SOC×SOC)

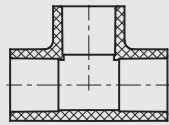

Part Number	Size (in)	Std PK	Mstr Ctn
401-003	3/8	50	400
401-005	1/2	50	300
401-007	3/4	50	300
401-010	1	50	200
401-012	1-1/4	25	100
401-015	1-1/2	25	100
401-020	2	25	0
401-025	2-1/2	10	0
401-030	3	10	0
401-040	4	6	0
401-050	5	5	0
401-060	6	2	0
401-080	8	5	0

REDUCING TEE (SOC×SOC×SOC)

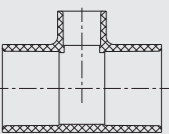

Part Number	Size (in)	Std PK	Mstr Ctn
401-418	4x4x1-1/4	10	0
401-419	4x4x1-1/2	10	0
401-420	4x4x2	10	0
401-422	4x4x3	6	0
401-486	5x5x2	5	0
401-488	5x5x3	8	0
401-490	5x5x4	6	0
401-528	6x6x2	6	0
401-530	6x6x3	5	0
401-532	6x6x4	5	0
401-582	8x8x4	8	0
401-585	8x8x6	5	0

TEE (SOC×SOC×FIPT)

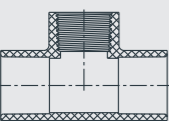

Part Number	Size (in)	Std PK	Mstr Ctn
402-005	1/2	50	300
402-007	3/4	50	300
402-010	1	50	200
402-012	1-1/4	25	100
402-015	1-1/2	25	100
402-020	2	10	60
402-025	2-1/2	15	0
402-030	3	10	0
402-040	4	6	0

REDUCING TEE (SOC×SOC×FIPT)

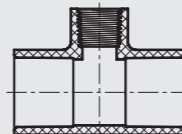

Part Number	Size (in)	Std PK	Mstr Ctn
402-071	1/2x1/2x1/8	50	200
402-072	1/2x1/2x1/4	50	400
402-074	1/2x1/2x3/4	50	200
402-094	3/4x1/2x1/2	50	200
402-095	3/4x1/2x3/4	50	300
402-101	3/4x3/4x1/2	50	200
402-124	1x3/4x1/2	50	300
402-125	1x3/4x3/4	40	240
402-130	1x1x1/2	50	200
402-131	1x1x3/4	50	200
402-156	1-1/4x1x1/2	25	100
402-157	1-1/4x1x3/4	25	150
402-158	1-1/4x1x1	25	150
402-166	1-1/4x1-1/4x1/2	25	150
402-167	1-1/4x1-1/4x3/4	25	150
402-168	1-1/4x1-1/4x1	25	150
402-199	1-1/2x1-1/4x1/2	25	150
402-201	1-1/2x1-1/4x3/4	25	150
402-202	1-1/2x1-1/4x1	25	150
402-209	1-1/2x1-1/2x1/2	25	150
402-210	1-1/2x1-1/2x3/4	25	100
402-211	1-1/2x1-1/2x1	25	100
402-212	1-1/2x1-1/2x1-1/4	25	100
402-239	2x1-1/2x1	10	40
402-247	2x2x1/2	10	40
402-248	2x2x3/4	10	60
402-249	2x2x1	10	40
402-250	2x2x1-1/4	10	60
402-251	2x2x1-1/2	10	60
402-287	2-1/2x2-1/2x1/2	10	40
402-288	2-1/2x2-1/2x3/4	10	40
402-289	2-1/2x2-1/2x1	10	40
402-290	2-1/2x2-1/2x1-1/4	10	40
402-291	2-1/2x2-1/2x1-1/2	10	40
402-292	2-1/2x2-1/2x2	8	32
402-333	3x3x1/2	8	32
402-334	3x3x3/4	8	32
402-335	3x3x1	8	32
402-336	3x3x1-1/4	8	32
402-337	3x3x1-1/2	10	0
402-338	3x3x2	6	24
402-416	4x4x3/4	6	24
402-417	4x4x1	6	24
402-418	4x4x1-1/4	10	0
402-419	4x4x1-1/2	10	0
402-420	4x4x2	10	0
402-422	4x4x3	6	0
402-490	5x5x4	6	0
402-525	6x6x1	6	0
402-528	6x6x2	4	0
402-530	6x6x3	4	0
402-532	6x6x4	2	0

PVC SCHEDULE 40 FITTINGS



TEE (SOC×FIPT ×SOC)

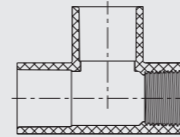

Part Number	Size (in)	Std PK	Mstr Ctn
403-005	1/2	50	300
403-007	3/4	50	300

90° STREET ELL (SPIG×FIPT)

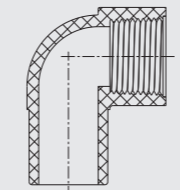

Part Number	Size (in)	Std PK	Mstr Ctn
404-005	1/2	50	400
404-007	3/4	50	300

TEE (FIPT×FIPT×FIPT)

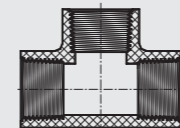

Part Number	Size (in)	Std PK	Mstr Ctn
405-005	1/2	50	300
405-007	3/4	50	200
405-010	1	50	200
405-012	1-1/4	25	150
405-015	1-1/2	25	100
405-020	2	10	60

90° ELL (SOC×SOC)

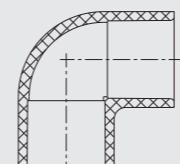

Part Number	Size (in)	Std PK	Mstr Ctn
406-003	3/8	50	600
406-005	1/2	50	400
406-007	3/4	50	200
406-010	1	50	300
406-012	1-1/4	25	150
406-015	1-1/2	25	100
406-020	2	20	80
406-025	2-1/2	10	40
406-030	3	10	0
406-040	4	8	0
406-050	5	4	0
406-060	6	3	0
406-080	8	4	0

90° SWEEP ELL (SOC×SOC)

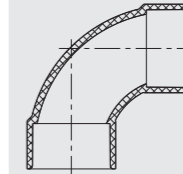

Part Number	Size (in)	Std PK	Mstr Ctn
406-015S	1-1/2	25	100
406-020S	2	15	60
406-025S	2-1/2	15	0
406-030S	3	25	0

90° REDUCING ELL (SOC×SOC)

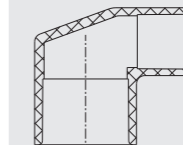

Part Number	Size (in)	Std PK	Mstr Ctn
406-053	3/8x1/2	50	400
406-101	3/4x1/2	50	300
406-130	1x1/2	50	300
406-131	1x3/4	50	300
406-166	1-1/4x1/2	25	150
406-167	1-1/4x3/4	25	150
406-168	1-1/4x1	25	150
406-209	1-1/2x1/2	25	100
406-211	1-1/2x1	25	100
406-212	1-1/2x1-1/4	25	100
406-249	2x1	10	40
406-250	2x1-1/4	10	40
406-251	2x1-1/2	10	40
406-292	2-1/2x2	10	40

90° ELL (SOC×FIPT)

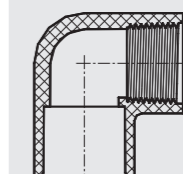

Part Number	Size (in)	Std PK	Mstr Ctn
407-005	1/2	50	400
407-007	3/4	50	200
407-010	1	50	300
407-012	1-1/4	25	150
407-015	1-1/2	25	100
407-020	2	10	40
407-025	2-1/2	9	36
407-030	3	6	24
407-040	4	7	0

Pressure Rating 150psi @73°F(23°C)

PVC SCHEDULE 40 FITTINGS



90° REDUCING ELL (SOC×FIPT)

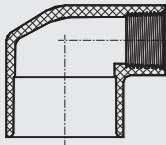

Part Number	Size (in)	Std PK	Mstr Ctn
407-053	3/8x1/2	50	400
407-074	1/2x3/4	50	300
407-101	3/4x1/2	50	300
407-130	1x1/2	50	200
407-131	1x3/4	50	300
407-168	1-1/4x1	25	100
407-211	1-1/2x1	25	100
407-212	1-1/2x1-1/4	15	60
407-249	2x1	10	40
407-250	2x1-1/4	10	40
407-251	2x1-1/2	10	40

90° STREET ELL (MIPT×SOC)

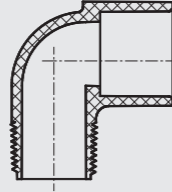

Part Number	Size (in)	Std PK	Mstr Ctn
410-005	1/2	50	400
410-007	3/4	50	200
410-010	1	50	300
410-012	1-1/4	25	100
410-015	1-1/2	25	100
410-020	2	10	40

90° ELL (FIPT×FIPT)

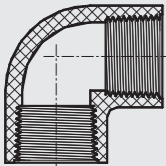

Part Number	Size (in)	Std PK	Mstr Ctn
408-005	1/2	50	400
408-007	3/4	50	300
408-010	1	50	300
408-012	1-1/4	25	150
408-015	1-1/2	35	140
408-020	2	10	60

90° REDUCING STREET ELL (MIPT×SOC)

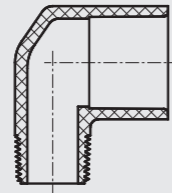

Part Number	Size (in)	Std PK	Mstr Ctn
410-101	3/4x1/2	50	300
410-102	3/4x1	50	200

90° STREET ELL (SPIG×SOC)

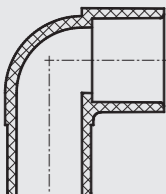

Part Number	Size (in)	Std PK	Mstr Ctn
409-005	1/2	50	400
409-007	3/4	50	200
409-010	1	50	300
409-012	1-1/4	25	150
409-015	1-1/2	25	100
409-020	2	10	60
409-025	2-1/2	10	40
409-030	3	15	0
409-040	4	10	0
409-060	6	5	0

11-1/4° ELL (SOC×SOC)

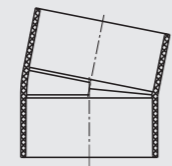

Part Number	Size (in)	Std PK	Mstr Ctn
411-100	10	4	0
411-120	12	2	0

PVC SCHEDULE 40 FITTINGS



90° STREET ELL (MIPT×FIPT)

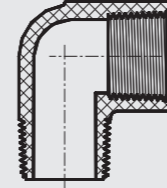

Part Number	Size (in)	Std PK	Mstr Ctn
412-005	1/2	50	400
412-007	3/4	50	300
412-010	1	50	300
412-012	1-1/4	25	100
412-015	1-1/2	25	150
412-020	2	10	40

22-1/2° ELL (SOC×SOC)

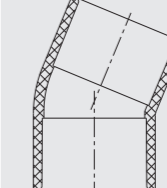

Part Number	Size (in)	Std PK	Mstr Ctn
416-015	1-1/2	20	80
416-020	2	20	120
416-025	2-1/2	10	60
416-030	3	20	0
416-040	4	12	0
416-060	6	4	0
416-100	10		

SIDE OUTLET ELL (SOC×SOC×SOC)

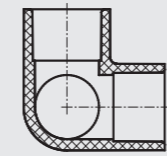

Part Number	Size (in)	Std PK	Mstr Ctn
413-005	1/2	50	300
413-007	3/4	50	300
413-010	1	25	150
413-015	1-1/2	10	60
413-020	2	10	40

45° ELL (SOC×SOC)

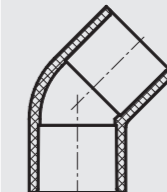

Part Number	Size (in)	Std PK	Mstr Ctn
417-005	1/2	50	400
417-007	3/4	50	200
417-010	1	50	300
417-012	1-1/4	25	150
417-015	1-1/2	25	100
417-020	2	25	100
417-025	2-1/2	10	40
417-030	3	15	0
417-040	4	4	16
417-050	5	10	0
417-060	6	5	0
417-080	8	6	0
417-100	10	4	0

SIDE OUTLET ELL (SOC×SOC×FIPT)

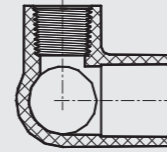

Part Number	Size (in)	Std PK	Mstr Ctn
414-005	1/2	50	300
414-007	3/4	50	300
414-101	3/4x3/4x1/2	50	200
414-010	1	20	80
414-130	1x1x1/2	50	200

CROSS (SOC×SOC×SOC×SOC)

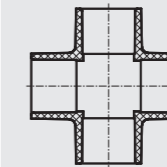

Part Number	Size (in)	Std PK	Mstr Ctn
420-005	1/2	50	200
420-007	3/4	50	200
420-010	1	25	100
420-012	1-1/4	50	0
420-015	1-1/2	25	0
420-020	2	8	32
420-025	2-1/2	10	0
420-030	3	6	0
420-040	4	6	0
420-060	6	2	0

DEEP SOCKET 45° ELL (SOC×SOC)

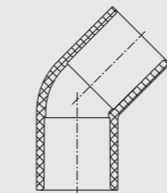

Part Number	Size (in)	Std PK	Mstr Ctn
417-020DS	2	20	80
417-025DS	2-1/2		
417-030DS	3	25	0

PVC SCHEDULE 40 FITTINGS



REDUCING CROSS (SOC×SOC×SOC×SOC)

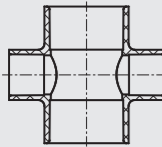

Part Number	Size (in)	Std PK	Mstr Ctn
420-101	3/4x3/4x1/2x1/2	50	300
420-249	2x2x1x1	10	40
420-251	2x2x1-1/2x1-1/2	10	40
420-335	3x3x1x1	18	0
420-337	3x3x1-1/2x1-1/2	15	0
420-338	3x3x2x2	12	0
420-419	4x4x1-1/2x1-1/2	8	0
420-420	4x4x2x2	6	0
420-422	4x4x3x3	5	0
420-528	6x6x2x2	3	0
420-532	6x6x4x4	2	0

45° STREET ELL (SPIG×SOC)

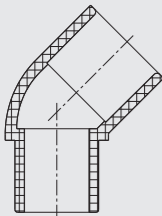

Part Number	Size (in)	Std PK	Mstr Ctn
427-005	1/2	50	600
427-007	3/4	50	200
427-010	1	50	200
427-012	1-1/4	25	100
427-015	1-1/2	25	150
427-020	2	25	100
427-025	2-1/2	10	40
427-030	3	5	30
427-040	4	20	0
427-060	6	8	0
427-080	8	6	0
427-100	10	4	0

COUPLING (SOC×SOC)

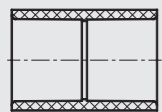

Part Number	Size (in)	Std PK	Mstr Ctn
429-003	3/8	50	600
429-005	1/2	50	600
429-007	3/4	50	400
429-010	1	50	200
429-012	1-1/4	25	150
429-015	1-1/2	25	100
429-020	2	25	100
429-025	2-1/2	12	72
429-030	3	10	40
429-040	4	6	24
429-050	5	15	0
429-060	6	6	0
429-080	8	8	0
429-100	10	8	0
429-120	12	2	0

REDUCING COUPLING (SOC×SOC)

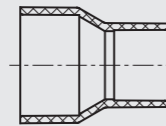

Part Number	Size (in)	Std PK	Mstr Ctn
429-101	3/4x1/2	50	400
429-130	1x1/2	25	300
429-131	1x3/4	50	300
429-166	1-1/4x1/2	25	150
429-167	1-1/4x3/4	25	150
429-168	1-1/4x1	25	150
429-209	1-1/2x1/2	25	150
429-210	1-1/2x3/4	25	150
429-211	1-1/2x1	25	100
429-212	1-1/2x1-1/4	25	100
429-247	2x1/2	10	80
429-248	2x3/4	10	80
429-249	2x1	25	150
429-250	2x1-1/4	10	80
429-251	2x1-1/2	10	80
429-291	2-1/2x1-1/2	10	40
429-292	2-1/2x2	10	40
429-338	3x2	8	32
429-340	3x2-1/2	8	32
429-420	4x2	4	16
429-421	4x2-1/2	6	24
429-422	4x3	4	16
429-528	6x2	10	0
429-530	6x3	15	0
429-532	6x4	5	0
429-582	8x4	12	0
429-585	8x6	12	0
429-626	10x6	8	0
429-628	10x8	8	0
429-668	12x8	3	0
429-670	12x10	3	0

ECCENTRIC REDUCER COUPLING (SOC×SOC)

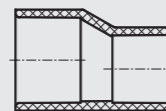

Part Number	Size (in)	Std PK	Mstr Ctn
429-168E	1-1/4x1	25	150
429-212E	1-1/2x1-1/4	25	100
429-251E	2x1-1/2	10	80
429-292E	2-1/2x2	10	60
429-338E	3x2	9	36
429-420E	4x2	15	0
429-421E	4x2-1/2	6	24
429-422E	4x3	12	0
429-528E	6x2	3	0
429-530E	6x3	3	0
429-532E	6x4	5	0

PVC SCHEDULE 40 FITTINGS



COUPLING (FIPT×FIPT)



Part Number	Size (in)	Std PK	Mstr Ctn
430-005	1/2	50	600
430-007	3/4	50	400
430-010	1	50	200
430-012	1-1/4	10	120
430-020	2	10	80

REDUCING COUPLING (FIPT×FIPT)

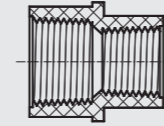

Part Number	Size (in)	Std PK	Mstr Ctn
430-101	3/4x1/2	50	400
430-131	1x3/4	50	300

RISER EXTENSION (FIPT×MIPT)

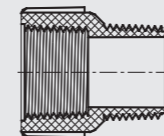

Part Number	Size (in)	Std PK	Mstr Ctn
434-005	1/2	50	600
434-007	3/4	50	400

FEMALE ADAPTER (SOC×FIPT)

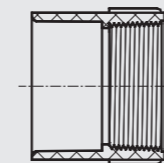

Part Number	Size (in)	Std PK	Mstr Ctn
435-003	3/8	100	1200
435-005	1/2	50	600
435-007	3/4	50	400
435-010	1	50	200
435-012	1-1/4	25	100
435-015	1-1/2	25	100
435-020	2	10	80
435-025	2-1/2	10	40
435-030	3	10	40
435-040	4	6	36

REDUCING FEMALE ADAPTER (SOC×FIPT)

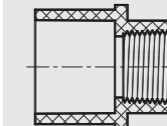

Part Number	Size (in)	Std PK	Mstr Ctn
435-072	1/2x1/4	50	600
435-073	1/2x3/8	50	600
435-074	1/2x3/4	100	600
435-101	3/4x1/2	50	400
435-102	3/4x1	25	200
435-130	1x1/2	50	200
435-131	1x3/4	50	200
435-133	1x1-1/2	25	150
435-168	1-1/4x1	25	100

MALE ADAPTER (MIPT×SOC)

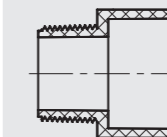

Part Number	Size (in)	Std PK	Mstr Ctn
436-003	3/8	50	600
436-005	1/2	50	600
436-007	3/4	50	400
436-010	1	50	200
436-012	1-1/4	25	150
436-015	1-1/2	25	100
436-020	2	25	100
436-025	2-1/2	10	40
436-030	3	10	60
436-040	4	4	16
436-060	6	6	0

REDUCING MALE ADAPTER (MIPT×SOC)

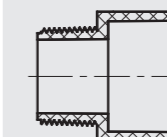

Part Number	Size (in)	Std PK	Mstr Ctn
436-053	3/8x1/2	50	600
436-073	1/2x3/8	50	600
436-074	1/2x3/4	50	400
436-075	1/2x1	40	240
436-101	3/4x1/2	50	600
436-102	3/4x1	50	300
436-131	1x3/4	50	400
436-132	1x1-1/4	50	300
436-133	1x1-1/2	50	300
436-168	1-1/4x1	25	200
436-169	1-1/4x1-1/2	25	150
436-212	1-1/2x1-1/4	25	100
436-213	1-1/2x2	25	100
436-251	2x1-1/2	10	80
436-252	2x2-1/2	10	40
436-253	2x3	10	60
436-342	3x4	5	30

PVC SCHEDULE 40 FITTINGS



REDUCING BUSHING FLUSH STYLE (SPIG×SOC)

Part Number	Size (in)	Std PK	Mstr Ctn
437-072	1/2x1/4	50	600
437-073	1/2x3/8	50	600
437-101	3/4x1/2	50	600
437-130	1x1/2	50	400
437-131	1x3/4	50	400
437-166	1-1/4x1/2	25	300
437-167	1-1/4x3/4	25	300
437-168	1-1/4x1	25	300
437-209	1-1/2x1/2	25	150
437-210	1-1/2x3/4	25	150
437-211	1-1/2x1	25	150
437-212	1-1/2x1-1/4	25	150
437-247	2x1/2	10	80
437-248	2x3/4	10	60
437-249	2x1	10	80
437-250	2x1-1/4	10	80
437-251	2x1-1/2	10	80
437-287	2-1/2x1/2	10	60
437-288	2-1/2x3/4	10	60
437-289	2-1/2x1	10	60
437-290	2-1/2x1-1/4	10	60
437-291	2-1/2x1-1/2	10	60
437-292	2-1/2x2	10	60
437-334	3x3/4	10	40
437-335	3x1	10	40
437-336	3x1-1/4	10	40
437-337	3x1-1/2	10	40
437-338	3x2	10	40
437-339	3x2-1/2	15	90
437-420	4x2	6	24
437-421	4x2-1/2	6	24
437-422	4x3	6	24
437-488	5x3	15	0
437-490	5x4	15	0
437-528	6x2	9	0
437-530	6x3	9	0
437-532	6x4	9	0
437-534	6x5	20	0
437-582	8x4	3	0
437-585	8x6	3	0
437-623	10x3	12	0
437-624	10x4	12	0
437-626	10x6	12	0
437-628	10x8	16	0
437-668	12x8	4	0
437-663	12x3	4	0
437-664	12x4	4	0
437-666	12x6	4	0
437-668	12x8	4	0
437-670	12x10	4	0

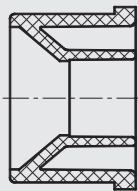

REDUCING BUSHING FLUSH STYLE (SPIG×FIPT)

Part Number	Size (in)	Std PK	Mstr Ctn
438-052	3/8x1/4	50	600
438-071	1/2x1/8	50	600
438-072	1/2x1/4	50	600
438-073	1/2x3/8	50	600
438-098	3/4x1/4	50	600
438-101	3/4x1/2	100	800
438-128	1x1/4	50	400
438-129	1x3/8	50	400
438-130	1x1/2	50	400
438-131	1x3/4	50	400
438-166	1-1/4x1/2	25	200
438-167	1-1/4x3/4	25	200
438-168	1-1/4x1	25	100
438-207	1-1/2x1/4	25	200
438-209	1-1/2x1/2	25	150
438-210	1-1/2x3/4	25	100
438-211	1-1/2x1	25	150
438-212	1-1/2x1-1/4	25	150
438-245	2x1/4	10	120
438-247	2x1/2	10	120
438-248	2x3/4	10	120
438-249	2x1	10	120
438-250	2x1-1/4	10	120
438-251	2x1-1/2	10	120
438-288	2-1/2x3/4	10	60
438-289	2-1/2x1	10	60
438-290	2-1/2x1-1/4	10	60
438-291	2-1/2x1-1/2	10	60
438-292	2-1/2x2	10	60
438-335	3x1	10	40
438-336	3x1-1/4	10	40
438-337	3x1-1/2	10	40
438-338	3x2	10	40
438-339	3x2-1/2	10	40
438-420	4x2	6	24
438-421	4x2-1/2	6	24
438-422	4x3	6	24
438-490	5x4	6	24
438-528	6x2	9	0
438-530	6x3	9	0
438-532	6x4	9	0

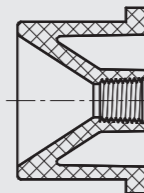

PVC SCHEDULE 40 FITTINGS



REDUCING T.T. BUSHING FLUSH STYLE (MIPT×FIPT)

Part Number	Size (in)	Std PK	Mstr Ctn
439-052	3/8x1/4	50	600
439-072	1/2x1/4	150	1800
439-073	1/2x3/8	50	600
439-098	3/4x1/4	50	600
439-099	3/4x3/8	50	600
439-101	3/4x1/2	50	600
439-128	1x1/4	25	300
439-130	1x1/2	50	600
439-131	1x3/4	50	600
439-166	1-1/4x1/2	25	300
439-167	1-1/4x3/4	25	300
439-168	1-1/4x1	25	300
439-198	1-1/2x2	40	240
439-209	1-1/2x1/2	25	200
439-210	1-1/2x3/4	25	200
439-211	1-1/2x1	25	200
439-212	1-1/2x1-1/4	25	200
439-248	2x3/4	10	120
439-249	2x1	10	120
439-250	2x1-1/4	10	120
439-251	2x1-1/2	10	120
439-292	2-1/2x2	10	60
439-338	3x2	10	60
439-422	4x3	6	24

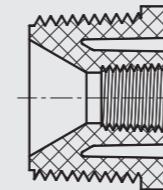

STREET TEE (SPIG×SOC×SOC)

Part Number	Size (in)	Std PK	Mstr Ctn
444-005	1/2	25	200
444-007	3/4	15	120
444-010	1	15	90
444-012	1-1/4	10	40
444-015	1-1/2	10	40
444-020	2	10	40

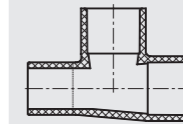

CAP (SOC)

Part Number	Size (in)	Std PK	Mstr Ctn
447-003	3/8	100	1200
447-005	1/2	100	1200
447-007	3/4	50	600
447-010	1	50	300
447-012	1-1/4	25	150
447-015	1-1/2	25	150
447-020	2	10	80
447-025	2-1/2	10	60
447-030	3	10	40
447-040	4	6	24
447-050	5	6	24
447-060	6	8	0
447-080	8	12	0
447-100	10	12	0
447-120	12	6	0

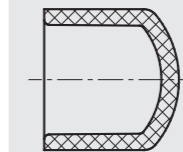

22-1/2° STREET ELL(SPIG×SOC)

Part Number	Size (in)	Std PK	Mstr Ctn
442-005	1/2	50	600
442-007	3/4	50	300
442-010	1	50	200
442-012	1-1/4	25	100
442-015	1-1/2	30	120
442-020	2	20	80
442-025	2-1/2	10	60
442-030	3	5	30
442-040	4	4	16
442-060	6	5	0

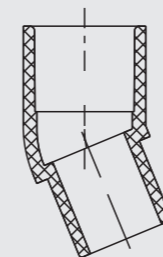

CAP (FIPT)

Part Number	Size (in)	Std PK	Mstr Ctn
448-003	3/8	100	1200
448-005	1/2	100	1200
448-007	3/4	50	600
448-010	1	50	400
448-012	1-1/4	25	200
448-015	1-1/2	25	150
448-020	2	10	120
448-025	2-1/2	10	60
448-030	3	10	40
448-040	4	6	36
448-060	6	13	0

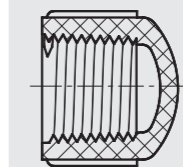

PVC SCHEDULE 40 FITTINGS



PLUG (SPIG)

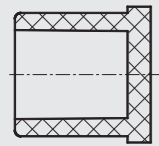

Part Number	Size (in)	Std PK	Mstr Ctn
449-003	3/8	150	1800
449-005	1/2	100	1200
449-007	3/4	50	600
449-010	1	50	400
449-012	1-1/4	25	200
449-015	1-1/2	25	150
449-020	2	10	120
449-025	2-1/2	10	60
449-030	3	10	40
449-040	4	6	24
449-060	6	8	0

PLUG (MIPT)

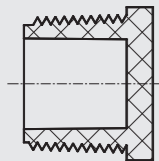

Part Number	Size (in)	Std PK	Mstr Ctn
450-003	3/8	100	1200
450-005	1/2	150	1800
450-007	3/4	100	1200
450-010	1	50	400
450-012	1-1/4	25	300
450-015	1-1/2	25	200
450-020	2	10	120
450-025	2-1/2	10	60
450-030	3	10	40
450-040	4	6	24
450-060	6	4	16

MALE ADAPTER (TAKE OFF) (SPIG×MIPT)

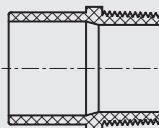

Part Number	Size (in)	Std PK	Mstr Ctn
461-005	1/2	50	600
461-007	3/4	50	400
461-010	1	50	300
461-015	1-1/2	25	100
461-020	2	25	100

SNAP-ON SADDLE (IPS O.D.×FIPT)

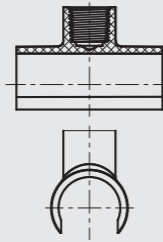

Part Number	Size (in)	Std PK	Mstr Ctn
464-007	3/4	25	200
464-101	3/4x1/2		
464-130	1x1/2	25	150
464-131	1x3/4		

Non-Pressure Rated
NSF Not Available

VENTURIED TEE (SOC×SOC(SPIG)×SOC(SPIG))

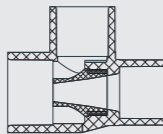

Part Number	Size (in)	Std PK	Mstr Ctn
473-210	1-1/2x1-1/2(2)x3/4(1)	30	120
473-825	1x3/4(1)x3/4(1)	40	240

INSERT ADAPTER (INSERT×SOC)

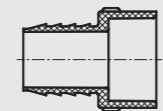

Part Number	Size (in)	Std PK	Mstr Ctn
474-007	3/4	50	400
474-010	1	25	200
474-015	1-1/2	25	100
474-020	2	20	80

ASTM D 2609 ASTM 2466
NSF Not Available

WYE (SOC×SOC×SOC)

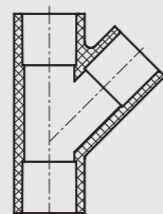

Part Number	Size (in)	Std PK	Mstr Ctn
475-005	1/2	25	150
475-007	3/4	20	80
475-010	1	20	120
475-012	1-1/4	20	80
475-015	1-1/2	15	60
475-020	2	10	40
475-025	2-1/2	3	12
475-030	3	6	0
475-040	4	5	0
475-060	6	2	0

Pressure Rating
1/2" - 2" 235psi @73°F(23°C)
2-1/2" - 6" 150psi @73°F(23°C)

PVC SCHEDULE 40 FITTINGS



REDUCING WYE (SOC×SOC×SOC)

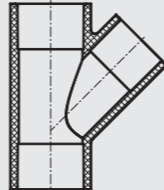

Part Number	Size (in)	Std PK	Mstr Ctn
475-101	3/4x3/4x1/2	20	120
475-131	1x1x3/4	20	80
475-210	1-1/2x1-1/2x3/4	20	80
475-211	1-1/2x1-1/2x1	20	80
475-212	1-1/2x1-1/2x1-1/4	15	60
475-251	2x2x1-1/2	10	40
475-292	2-1/2x2-1/2x2	4	24
475-338	3x3x2	10	0
475-339	3x3x2-1/2	8	0
475-420	4x4x2	5	0
475-422	4x4x3	5	0
475-528	6x6x2	5	0
475-530	6x6x3	5	0
475-532	6x6x4	3	0

Pressure Rating
1/2" - 2" 235psi @73°F(23°C)
2-1/2" - 6" 150psi @73°F(23°C)

SPIGOT FEMALE ADAPTER (SPIG X FIPT)

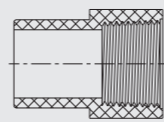

Part Number	Size (in)	Std PK	Mstr Ctn
478-005	1/2	50	600
478-007	3/4	25	300
478-010	1	40	240
478-012	1-1/4	30	120
478-015	1-1/2	30	120
478-020	2	25	100

DEEP SOCKET COUPLING (SOC×SOC)

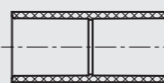

Part Number	Size (in)	Std PK	Mstr Ctn
479-005	1/2	50	400
479-007	3/4	50	300
479-010	1	50	300
479-012	1-1/4	50	200
479-015	1-1/2	30	120
479-020	2	60	0
479-025	2-1/2	25	0
479-030	3	20	0
479-040	4	10	0
479-060	6	5	0

UNION W/O-RING SEAL (SOC×SOC)

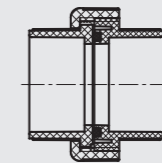

Part Number	Size (in)	Std PK	Mstr Ctn
497-005	1/2	20	240
497-007	3/4	10	120
497-010	1	10	80
497-012	1-1/4	8	64
497-015	1-1/2	10	40
497-020	2	5	30

Pressure Rating 150psi @73°F(23°C)

UNION W/O-RING SEAL (FIPT×FIPT)

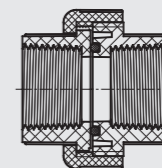

Part Number	Size (in)	Std PK	Mstr Ctn
498-005	1/2	20	240
498-007	3/4	10	120
498-010	1	10	80
498-012	1-1/4	8	64
498-015	1-1/2	15	60
498-020	2	5	30

Pressure Rating 150psi @73°F(23°C)

COMPRESSION COUPLING(GASKET×GASKET)

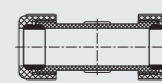

Part Number	Size (in)	Std PK	Mstr Ctn
IR90-05	1/2	30	120
IR90-07	3/4	30	180
IR90-10	1	10	40
IR90-12	1-1/4	15	60
IR90-15	1-1/2	10	40
IR90-20	2	6	24
IR90-25	2-1/2	15	0
IR90-30	3	7	0
IR90-40	4	10	0
IR90-60	6	3	0

Pressure Rating 150psi @73°F(23°C)



COMPRESSION TEE (GASKET×GASKET×FIPT)

Part Number	Size (in)	Std PK	Mstr Ctn
IR91-05	1/2	30	180
IR91-07	3/4	25	150
IR91-10	1	10	40

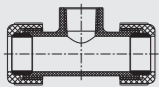

Pressure Rating 150psi @73°F(23°C)

EXPAND REPAIR COUPLING (SOC×SPIG)

Part Number	Size (in)	Std PK	Mstr Ctn
FSF-050	1/2	25	100
FSF-075	3/4	20	80
FSF-100	1	10	40
FSF-125	1-1/4	6	24
FSF-150	1-1/2	6	24
FSF-200	2	18	0
FSF-250	2-1/2	20	0
FSF-300	3	6	0
FSF-400	4	7	0
FSF-600	6	2	0



Fitting Terms and Abbreviations:

- ELL: Elbow
- SOC: Solvent Weld Socket
- SPIG: Spigot End (pipe O.D. size)
- MIPT: Male Iron Pipe Thread
- FIPT: Female Iron Pipe Thread
- INSERT: Barbed Insert End
- GASKET: Elastomer Gasket Sealed Connection
- IPS O.D.: Iron Pipe Size Outside Diameter
- W/: with

Note: part of item aren't listed in upc certification

PVC UVR Sch40 Fittings

QUALITY

LESSO America's plastic fittings line is renowned worldwide for its Superior quality, which complies with cNSFus and UPC certifications, and exceeds the requirements of ASTM standards and CSA standards.

REFERENTIAL STANDARDS

NSF/ANSI 61 Drinking Water System Components - Health Effects

NSF/ANSI 14 Plastics Piping System Components and Related Materials

ASTM D 1784 Standard Specification for Rigid Poly(Vinyl Chloride)(PVC) Compounds and Chlorinated Poly(Vinyl Chloride) (CPVC) Compounds

ASTM D 2466 Standard Specification for Poly(Vinyl Chloride) (PVC) Plastic Pipe Fittings, Schedule 40

CSA B 137.3 Rigid Polyvinylchloride (PVC) Pipe and Fittings for Pressure Applications



COLUMN HEADER INFORMATION

Each product column header label identifies the following product particulars:

Part Number: the number used to order the part.

Size: nominal diameter of pipe with which the fitting is to be used.

NOTE: Fittings may be same size (only one size designation) or reducing (multiple sizes designated).

Standard Pack (Std Pk) the quantity of parts packaged in an individual box or bag.

Master Carton (Mstr Ctn) the total quantity of parts contained in individual boxes or bags which are packaged together.

METHODS OF DESIGNATING INLETS OF FITTINGS

PVC UVR SCHEDULE 40 FITTINGS

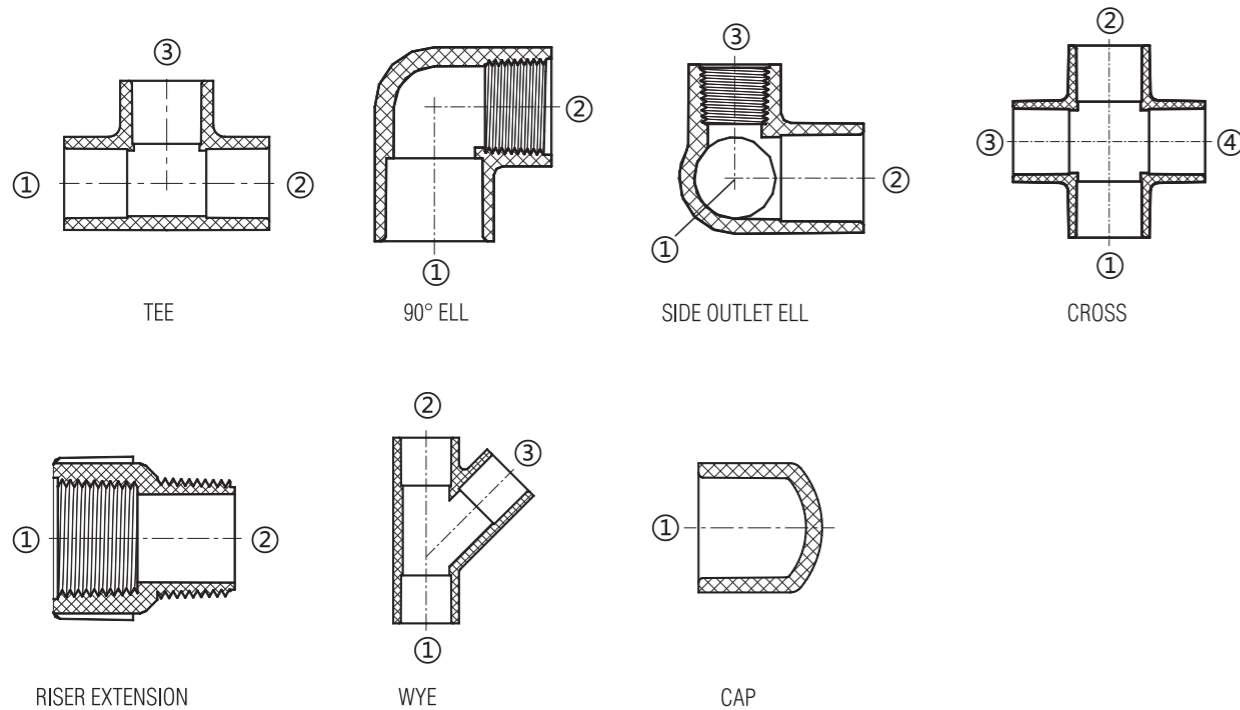

PVC UVR SCH40 FITTINGS



TEE (SOC×SOC×SOC)

Part Number	Size (in)	Std PK	Mstr Ctn
UV401-005	1/2	50	300
UV401-007	3/4	50	300
UV401-010	1	50	200
UV401-012	1-1/4	25	100
UV401-015	1-1/2	25	100
UV401-020	2	25	0
UV401-025	2-1/2	10	0
UV401-030	3	10	0
UV401-040	4	6	0

90° ELL (SOC×SOC)

Part Number	Size (in)	Std PK	Mstr Ctn
UV406-005	1/2	50	400
UV406-007	3/4	50	200
UV406-010	1	50	300
UV406-012	1-1/4	25	150
UV406-015	1-1/2	25	100
UV406-020	2	20	80
UV406-025	2-1/2	10	40
UV406-030	3	10	0
UV406-040	4	8	0

TEE (SOC×SOC×FIPT)

Part Number	Size (in)	Std PK	Mstr Ctn
UV402-005	1/2	50	300
UV402-007	3/4	50	300
UV402-010	1	50	200

90° ELL (SOC×FIPT)

Part Number	Size (in)	Std PK	Mstr Ctn
UV407-005	1/2	50	400
UV407-007	3/4	50	200

REDUCING TEE (SOC×SOC× FIPT)

Part Number	Size (in)	Std PK	Mstr Ctn
UV402-101	3/4x3/4x1/2	50	200
UV402-130	1x1x1/2	50	200
UV402-131	1x1x3/4	50	200
UV402-166	1-1/4x1-1/4x1/2	25	150
UV402-167	1-1/4x1-1/4x3/4	25	150
UV402-209	1-1/2x1-1/2x1/2	25	150
UV402-210	1-1/2x1-1/2x3/4	25	100
UV402-247	2x2x1/2	10	40
UV402-248	2x2x3/4	10	60

90° REDUCING ELL (SOC×FIPT)

Part Number	Size (in)	Std PK	Mstr Ctn
UV407-101	3/4x1/2	50	300
UV407-130	1x1/2	50	200
UV407-131	1x3/4	50	300

45° ELL (SOC×SOC)

Part Number	Size (in)	Std PK	Mstr Ctn
UV417-005	1/2	50	400
UV417-007	3/4	50	200
UV417-010	1	50	300
UV417-012	1-1/4	25	150
UV417-015	1-1/2	25	100
UV417-020	2	25	100
UV417-025	2-1/2	10	40
UV417-030	3	15	0
UV417-040	4	4	16

90° ELL (FIPT×FIPT)

Part Number	Size (in)	Std PK	Mstr Ctn
UV408-005	1/2	50	400
UV408-007	3/4	50	300
UV408-010	1	50	300
UV408-012	1-1/4	25	150
UV408-015	1-1/2	35	140
UV408-020	2	10	60

90° STREET ELL (MIPT×FIPT)

Part Number	Size (in)	Std PK	Mstr Ctn
UV412-005	1/2	50	400
UV412-007	3/4	50	300

PVC UVR SCH40 FITTINGS



COUPLING (SOC×SOC)

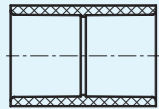

Part Number	Size (in)	Std PK	Mstr Ctn
UV429-005	1/2	50	600
UV429-007	3/4	50	400
UV429-010	1	50	200
UV429-012	1-1/4	25	150
UV429-015	1-1/2	25	100
UV429-020	2	25	100
UV429-025	2-1/2	12	72
UV429-030	3	10	40
UV429-040	4	6	24

COUPLING (FIPT×FIPT)

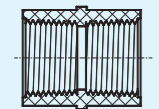

Part Number	Size (in)	Std PK	Mstr Ctn
UV430-005	1/2	50	600
UV430-007	3/4	50	400

FEMALE ADAPTER (SOC×FIPT)

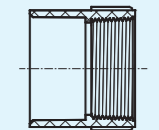

Part Number	Size (in)	Std PK	Mstr Ctn
UV435-005	1/2	50	600
UV435-007	3/4	50	400

REDUCING MALE ADAPTER (MIPT×SOC)

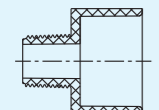

Part Number	Size (in)	Std PK	Mstr Ctn
UV436-074	1/2x3/4	50	400
UV436-131	1x3/4	50	400

MALE ADAPTER (MIPT×SOC)

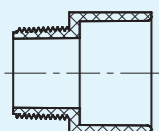

Part Number	Size (in)	Std PK	Mstr Ctn
UV436-005	1/2	50	600
UV436-007	3/4	50	400
UV436-010	1	50	200
UV436-012	1-1/4	25	150
UV436-015	1-1/2	25	100
UV436-020	2	25	100
UV436-025	2-1/2	10	40
UV436-030	3	10	60

REDUCING BUSHING FLUSH STYLE (SPIG×SOC)

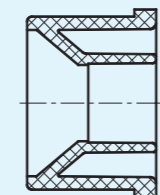

Part Number	Size (in)	Std PK	Mstr Ctn
UV437-101	3/4x1/2	50	600
UV437-130	1x1/2	50	400
UV437-131	1x3/4	50	400
UV437-167	1-1/4x3/4	25	300
UV437-168	1-1/4x1	25	300
UV437-210	1-1/2x3/4	25	150
UV437-211	1-1/2x1	25	150
UV437-212	1-1/2x1-1/4	25	150
UV437-249	2x1	10	80
UV437-250	2x1-1/4	10	80
UV437-251	2x1-1/2	10	80
UV437-288	2-1/2x3/4	10	60
UV437-289	2-1/2x1	10	60
UV437-290	2-1/2x1-1/4	10	60
UV437-291	2-1/2x1-1/2	10	60
UV437-292	2-1/2x2	10	60
UV437-335	3x1	10	40
UV437-336	3x1-1/4	10	40
UV437-337	3x1-1/2	10	40
UV437-338	3x2	10	40
UV437-339	3x2-1/2	15	90
UV437-422	4x3	6	24

REDUCING BUSHING FLUSH STYLE (SPIG×FIPT)

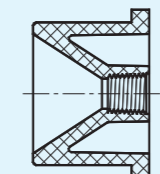

Part Number	Size (in)	Std PK	Mstr Ctn
UV438-101	3/4x1/2	100	800
UV438-130	1x1/2	50	400
UV438-131	1x3/4	50	400
UV438-168	1-1/4x1	25	100
UV438-211	1-1/2x1	25	150
UV438-288	2-1/2x3/4	10	60

Fitting Terms and Abbreviations:

- ELL: Elbow
- SOC: Solvent Weld Socket
- SPIG: Spigot End (pipe O.D. size)
- MIPT: Male Iron Pipe Thread
- FIPT: Female Iron Pipe Thread

Note: part of item aren't listed in upc certification

PVC Schedule 80 Fittings

QUALITY

LESSO America's plastic fittings line is renowned worldwide for its superior quality, which complies with cNSFus certifications, and the requirements of ASTM standards and CSA standards.

REFERENTIAL STANDARDS

NSF/NASI 61 Drinking Water System Components-Health Effects

NSF/NASI 14 Plastics Piping System Components and Related Materials

ASTM D 1784 Standard Specification for Rigid Poly (Viny Chloride) (PVC) Compounds and Chlorinated Poly (Viny Chloride) (CPVC) Compounds

ASTM D 2467 Standard Specification for Rigid Poly (Viny Chloride) (PVC) Plastic Pipe Fittings, Schedule 80

ASTM F 1970 Standard Specification for Special Engineered Fittings, Appurtenances or Valves for use in Poly (Viny Chloride) (PVC) or Chlorinated Poly (Viny Chloride) (CPVC) Systems

CSA B137.3 Rigid Polyvinylchloride (PVC) Pipe and Fittings for Pressure Applications.



COLUMN HEADER INFORMATION

Each product column header label identifies the following product particulars:

Part Number: the number used to order the part.

Size: nominal diameter of pipe with which the fitting is to be used.

NOTE: Fittings may be same size (only one size designation) or reducing (multiple sizes designated).

Standard Pack (Std Pk) the quantity of parts packaged in an individual box or bag.

Master Carton (Mstr Ctn) the total quantity of parts contained in individual boxes or bags which are packaged together.

METHODS OF DESIGNATING INLETS OF FITTINGS

PVC SCHEDULE 80 FITTINGS

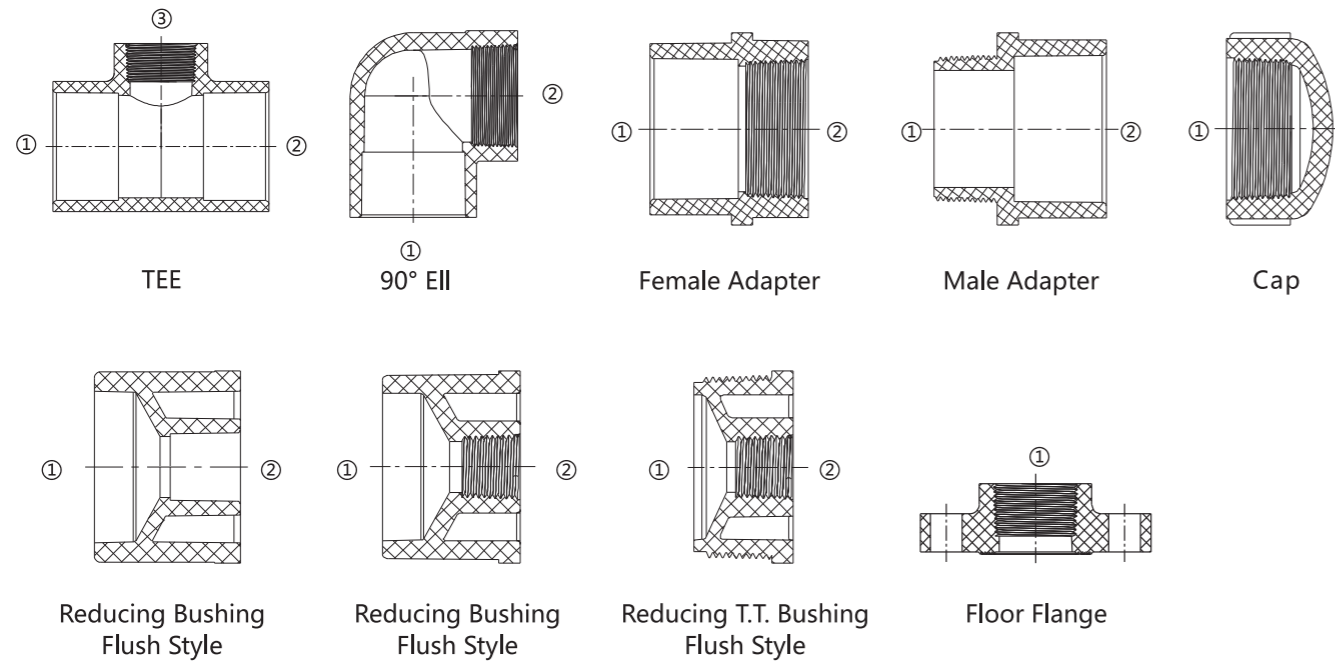

PVC SCHEDULE 80 FITTINGS



TEE (SOC×SOC×SOC)

Part Number	Size (in)	Std PK	Mstr Ctn
801-002	1/4	50	600
801-005	1/2	25	200
801-007	3/4	15	120
801-010	1	20	80
801-012	1-1/4	10	40
801-015	1-1/2	5	30
801-020	2	5	20
801-025	2-1/2	10	0
801-030	3	5	0
801-040	4	5	0
801-060	6	2	0
801-080	8	5	0

REDUCING TEE (SOC×SOC×FIPT)

Part Number	Size (in)	Std PK	Mstr Ctn
802-251	2x2x1-1/2	10	40
802-291	2-1/2x2-1/2x1-1/2	10	40

REDUCING TEE (SOC×SOC×SOC)

Part Number	Size (in)	Std PK	Mstr Ctn
801-101	3/4x3/4x1/2	15	120
801-130	1x1x1/2	15	90
801-131	1x1x3/4	15	90
801-168	1-1/4x1-1/4x1	15	60
801-210	1-1/2x1-1/2x3/4		
801-211	1-1/2x1-1/2x1		
801-247	2x2x1/2	10	60
801-248	2x2x3/4	10	60
801-249	2x2x1	10	60
801-250	2x2x1-1/4	10	40
801-251	2x2x1-1/2	10	40
801-290	2-1/2x2-1/2x1-1/4	10	40
801-291	2-1/2x2-1/2x1-1/2	9	36
801-292	2-1/2x2-1/2x2	36	0
801-337	3x3x1-1/2	10	0
801-338	3x3x2	10	0
801-420	4x4x2	5	0
801-422	4x4x3	5	0
801-530	6x6x3	3	0
801-532	6x6x4	4	0
801-585	8x8x6	2	0

TEE (FIPT×FIPT×FIPT)

Part Number	Size (in)	Std PK	Mstr Ctn
805-002	1/4	50	600
805-003	3/8	50	400
805-005	1/2	20	240
805-007	3/4		
805-010	1	15	90
805-012	1-1/4	10	40
805-015	1-1/2	10	40
805-020	2	10	40
805-025	2-1/2		
805-030	3	6	0
805-040	4	5	0

TEE (SOC×SOC×FIPT)

Part Number	Size (in)	Std PK	Mstr Ctn
802-005	1/2	20	120
802-007	3/4		
802-010	1	15	60
802-015	1-1/2	10	40
802-020	2	5	20

90° Ell (SOC×SOC)

Part Number	Size (in)	Std PK	Mstr Ctn
806-002	1/4	50	600
806-003	3/8	20	240
806-005	1/2	25	300
806-007	3/4	20	160
806-010	1	25	100
806-012	1-1/4	10	60
806-015	1-1/2	15	60
806-020	2	8	32
806-025	2-1/2	5	30
806-030	3	5	20
806-040	4	5	0
806-060	6	4	0
806-080	8	4	0

PVC SCHEDULE 80 FITTINGS



90° EII (SOC×FIPT)

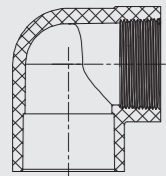

Part Number	Size (in)	Std PK	Mstr Ctn
807-005	1/2	20	240
807-007	3/4	25	200
807-010	1	25	100
807-012	1-1/4	10	60
807-015	1-1/2	10	40
807-020	2	15	60

45° EII (FIPT×FIPT)

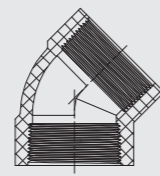

Part Number	Size (in)	Std PK	Mstr Ctn
819-005	1/2	30	360
819-007	3/4	20	240
819-010	1		
819-012	1-1/4	10	80
819-015	1-1/2	10	60
819-020	2	10	40
819-025	2-1/2	8	48
819-030	3	6	24
819-040	4	8	0

90° EII (FIPT×FIPT)

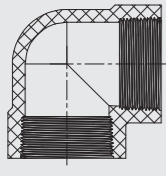

Part Number	Size (in)	Std PK	Mstr Ctn
808-002	1/4	50	600
808-003	3/8	50	600
808-005	1/2	20	240
808-007	3/4	25	200
808-010	1	15	90
808-012	1-1/4	10	60
808-015	1-1/2	10	40
808-020	2		
808-025	2-1/2	6	36
808-030	3	5	20
808-040	4	20	0

Cross (SOC×SOC×SOC×SOC)

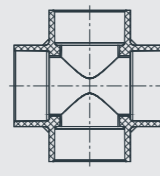

Part Number	Size (in)	Std PK	Mstr Ctn
820-030	3	15	0
820-040	4	3	0

45° EII (SOC×SOC)

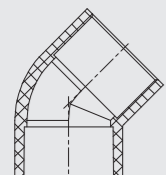

Part Number	Size (in)	Std PK	Mstr Ctn
817-002	1/4	50	600
817-003	3/8	25	300
817-005	1/2	30	360
817-007	3/4	20	240
817-010	1	20	120
817-012	1-1/4	15	90
817-015	1-1/2		
817-020	2	10	40
817-025	2-1/2	60	0
817-030	3	16	0
817-040	4	9	0
817-060	6	2	0

COUPLING (SOC×SOC)

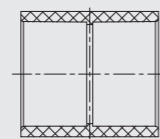

Part Number	Size (in)	Std PK	Mstr Ctn
829-002	1/4	50	600
829-005	1/2	35	420
829-007	3/4	25	300
829-010	1	25	150
829-012	1-1/4	10	80
829-015	1-1/2	10	80
829-020	2	10	60
829-025	2-1/2	10	60
829-030	3	25	0
829-040	4	12	0
829-060	6	4	0
829-080	8	6	0
829-100	10	8	0
829-120	12	1	0

PVC SCHEDULE 80 FITTINGS



REDUCING COUPLING (SOC×SOC)

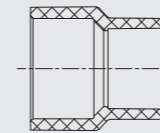

Part Number	Size (in)	Std PK	Mstr Ctn
829-101	3/4x1/2	50	300
829-130	1x1/2	25	150
829-131	1x3/4	25	150
829-166	1-1/4x1/2	25	150
829-167	1-1/4x3/4	25	150
829-168	1-1/4x1	35	140
829-210	1-1/2x3/4	25	100
829-211	1-1/2x1		
829-212	1-1/2x1-1/4	20	80
829-251	2x1-1/2	20	120
829-338	3x2	5	20
829-422	4x3	10	40
829-532	6x4	4	0
829-585	8x6	4	0

MALE ADAPTER (MIPT×SOC)

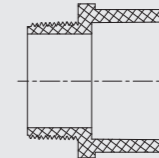

Part Number	Size (in)	Std PK	Mstr Ctn
836-005	1/2	25	300
836-007	3/4	25	300
836-010	1	20	160
836-012	1-1/4	10	120
836-015	1-1/2		
836-020	2	10	60
836-025	2-1/2	6	36
836-030	3	8	48
836-040	4	4	16

COUPLING (FIPT×FIPT)

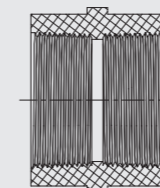

Part Number	Size (in)	Std PK	Mstr Ctn
830-002	1/4	50	600
830-005	1/2	25	300
830-007	3/4	25	300
830-010	1	15	180
830-012	1-1/4	10	120
830-015	1-1/2	10	80
830-020	2		
830-025	2-1/2	5	20
830-030	3	5	20
830-040	4	8	32

REDUCING BUSHING FLUSH STYLE (SPIG×SOC)

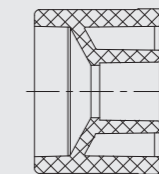

Part Number	Size (in)	Std PK	Mstr Ctn
837-052	3/8x1/4	100	1200
837-072	1/2x1/4	100	1200
837-073	1/2x3/8	50	600
837-101	3/4x1/2	50	600
837-130	1x1/2	50	400
837-131	1x3/4	50	400
837-166	1-1/4x1/2	50	300
837-167	1-1/4x3/4	50	300
837-168	1-1/4x1	25	200
837-209	1-1/2x1/2	30	180
837-210	1-1/2x3/4	30	180
837-211	1-1/2x1	25	150
837-212	1-1/2x1-1/4	25	150
837-247	2x1/2	25	150
837-248	2x3/4	10	120
837-249	2x1	10	120
837-250	2x1-1/4	10	120
837-251	2x1-1/2	10	120
837-289	2-1/2x1	10	60
837-290	2-1/2x1-1/4		
837-291	2-1/2x1-1/2	10	60
837-292	2-1/2x2		
837-335	3x1	10	40
837-337	3x1-1/2	10	40
837-338	3x2	10	40
837-339	3x2-1/2	10	40
837-420	4x2	6	24
837-421	4x2-1/2	6	24
837-422	4x3*	6	24
837-528	6x2	9	0
837-530	6x3	6	0
837-532	6x4	9	0
837-626	10x6	16	0
837-628	10x8	16	0

FEMALE ADAPTER (SOC×FIPT)

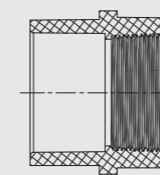

Part Number	Size (in)	Std PK	Mstr Ctn
835-002	1/4	50	600
835-005	1/2	30	360
835-007	3/4	30	240
835-010	1	25	150
835-012	1-1/4	10	120
835-015	1-1/2	10	80
835-020	2	15	60
835-025	2-1/2		
835-030	3	5	30
835-040	4	5	20

PVC SCHEDULE 80 FITTINGS



REDUCING BUSHING FLUSH STYLE (SPIG×FIPT)

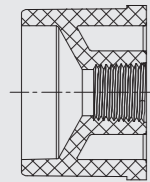

Part Number	Size (in)	Std PK	Mstr Ctn
838-052	3/8x1/4	100	1200
838-072	1/2x1/4	100	1200
838-101	3/4x1/2	50	600
838-130	1x1/2	50	400
838-131	1x3/4	50	400
838-166	1-1/4x1/2	25	300
838-167	1-1/4x3/4	20	240
838-168	1-1/4x1	25	200
838-209	1-1/2x1/2	30	180
838-210	1-1/2x3/4	25	150
838-211	1-1/2x1	25	150
838-212	1-1/2x1-1/4	25	150
838-247	2x1/2	10	120
838-248	2x3/4	10	120
838-249	2x1	10	120
838-250	2x1-1/4	10	120
838-251	2x1-1/2	10	120
838-292	2-1/2x2	10	60
838-338	3x2	10	40
838-339	3x2-1/2	10	40
838-420	4x2		
838-422	4x3	6	24
838-532	6x4	6	0

REDUCING T.T. BUSHING FLUSH STYLE (MIPT×FIPT)

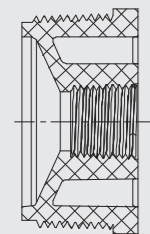

Part Number	Size (in)	Std PK	Mstr Ctn
839-072	1/2x1/4	100	1200
839-073	1/2x3/8	100	1200
839-098	3/4x1/4	100	1200
839-099	3/4x3/8	100	1200
839-101	3/4x1/2	50	600
839-129	1x3/8	50	600
839-130	1x1/2	50	600
839-131	1x3/4	50	600
839-166	1-1/4x1/2	35	420
839-167	1-1/4x3/4	25	300
839-168	1-1/4x1	25	300
839-210	1-1/2x3/4	25	200
839-211	1-1/2x1	25	200
839-212	1-1/2x1-1/4		
839-247	2x1/2	10	120
839-292	2-1/2x2	10	60

CAP (SOC)

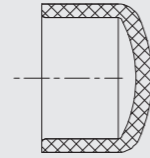

Part Number	Size (in)	Std PK	Mstr Ctn
847-002	1/4	100	1200
847-003	3/8	50	600
847-005	1/2	65	780
847-007	3/4	40	480
847-010	1	20	240
847-012	1-1/4	10	120
847-015	1-1/2	10	120
847-020	2	10	80
847-025	2-1/2	15	60
847-030	3	5	20
847-040	4	5	20
847-060	6	4	0
847-080	8	12	0

CAP (FIPT)

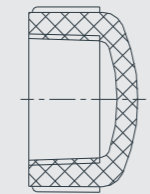

Part Number	Size (in)	Std PK	Mstr Ctn
848-002	1/4	100	1200
848-003	3/8	50	600
848-005	1/2	50	600
848-007	3/4	40	480
848-010	1	20	240
848-012	1-1/4	10	120
848-015	1-1/2		
848-020	2	10	60
848-025	2-1/2	10	60
848-030	3	8	32
848-040	4	5	20

PLUG (SPIG)

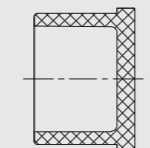

Part Number	Size (in)	Std PK	Mstr Ctn
849-010	1	50	300
849-020	2	10	120

PVC SCHEDULE 80 FITTINGS



PLUG (MIPT)

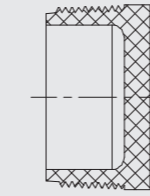

Part Number	Size (in)	Std PK	Mstr Ctn
850-002	1/4	100	1200
850-003	3/8	100	1200
850-005	1/2	150	1800
850-007	3/4	100	1200
850-010	1	50	600
850-012	1-1/4	30	360
850-015	1-1/2	10	120
850-020	2	10	120
850-025	2-1/2	10	60
850-030	3	10	60
850-040	4	8	32

FLANGE ONE PIECE (SOC)

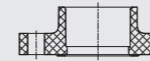

Part Number	Size (in)	Std PK	Mstr Ctn
851-025	2-1/2	15	0
851-030	3	12	0

FLOOR FLANGE (FIPT)

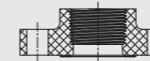

Part Number	Size (in)	Std PK	Mstr Ctn
852-005	1/2	20	120
852-007	3/4	25	150
852-010	1	15	60
852-012	1-1/4	15	60

BLIND FLANGE



Part Number	Size (in)	Std PK	Mstr Ctn
853-025	2-1/2	25	0
853-030	3	20	0

WYE (SOC X SOC X SOC)

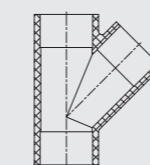

Part Number	Size (in)	Std PK	Mstr Ctn
875-020	2		
875-040	4	3	0
875-060	6	2	0

REDUCING NIPPLE (MIPT×MIPT)

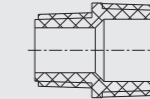

Part Number	Size (in)	Std PK	Mstr Ctn
882-101	3/4x1/2	50	600

UNION W/O-RING SEAL (SOC×SOC)

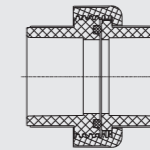

Part Number	Size (in)	Std PK	Mstr Ctn
897-002	1/4	25	300
897-005	1/2	10	120
897-007	3/4	20	120
897-010	1	10	80
897-012	1-1/4	10	40
897-015	1-1/2	5	30
897-020	2	10	40
897-030	3	5	20

PVC Fittings rated as 235psi at 23°C

UNION W/O-RING SEAL (FIPT×FIPT)

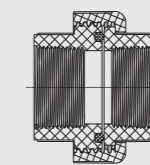

Part Number	Size (in)	Std PK	Mstr Ctn
898-005	1/2	20	160
898-007	3/4	20	120
898-010	1	10	80
898-012	1-1/4	10	60
898-015	1-1/2	10	40

PVC Fittings rated as 235psi at 23°C

UNION W/O-RING SEAL (SOC×FIPT)

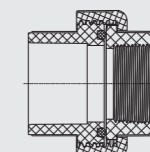

Part Number	Size (in)	Std PK	Mstr Ctn
899-005	1/2	20	160
899-007	3/4	20	120
899-010	1	10	80
899-012	1-1/4	15	60
899-015	1-1/2	10	40
899-020	2	5	30

PVC DWV Fittings

QUALITY

LESSO America's plastic fittings line is renowned worldwide for its superior quality, which complies with cNSFus and cUPC certifications, and exceeds the requirements of ASTM standards and CSA standards.

REFERENTIAL STANDARDS

NSF/ANSI 14 Plastics Piping System Components and Related Materials

NSF SE 7992 ABS and PVC DWV Fitting with Alternate Fitting Patterns

ASTM D 1784 Standard Specification for Rigid Poly(Vinyl Chloride) (PVC) Compounds and Chlorinated Poly(Vinyl Chloride) (CPVC) Compounds

ASTM D 2665 Standard Specification for Poly(Vinyl Chloride) (PVC) Plastic Drain, Waste, and Vent Pipe and Fittings

CSA B 181.2 Polyvinylchloride (PVC) and Chlorinated Polyvinylchloride (CPVC) Drain, Waste, and Vent Pipe and Pipe Fittings

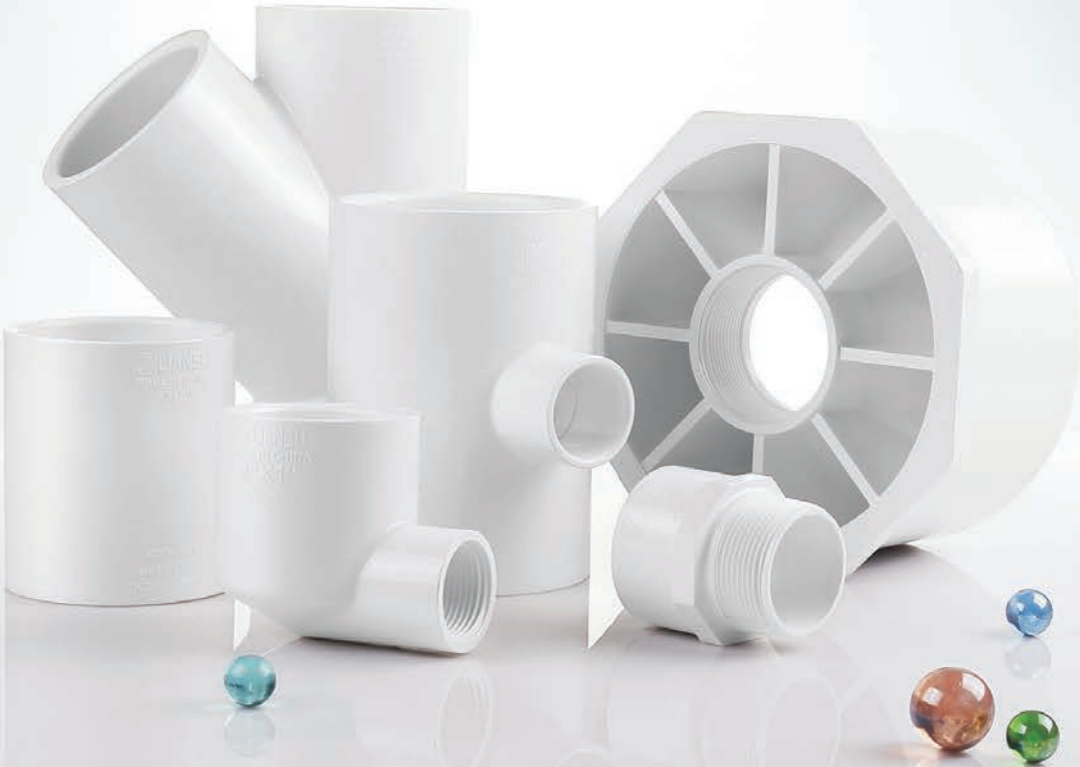

COLUMN HEADER INFORMATION

Each product column header label identifies the following product particulars:

Part Number: the number used to order the part.

Size: nominal diameter of pipe with which the fitting is to be used.

NOTE: Fittings may be same size (only one size designation) or reducing (multiple sizes designated).

Standard Pack (Std Pk) the quantity of parts packaged in an individual box or bag.

Master Carton (Mstr Ctn) the total quantity of parts contained in individual boxes or bags which are packaged together.

METHODS OF DESIGNATING INLETS OF FITTINGS

PVC SCHEDULE 40 FITTINGS

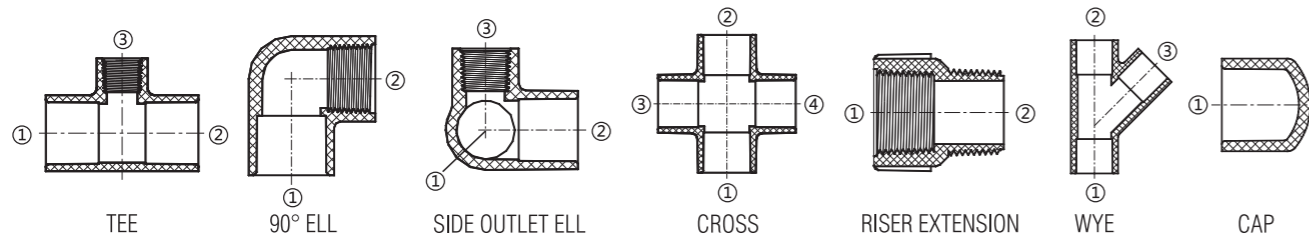

PVC DWV FITTINGS

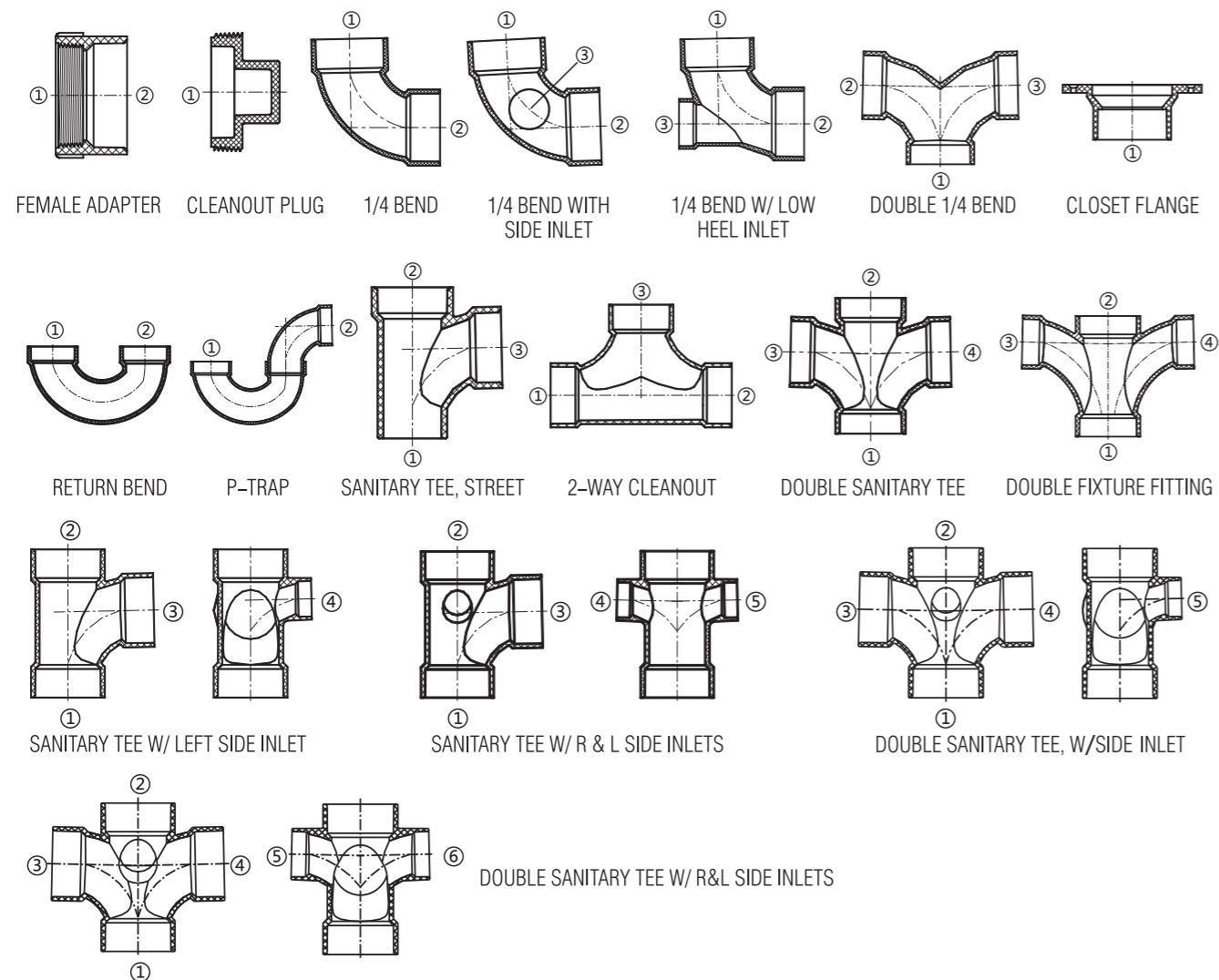

PVC DWV FITTINGS



COUPLING (H×H)

Part Number	Size (in)	Std Pk	Mstr Ctn
LP100-012	1-1/4	100	400
LP100-015	1-1/2	100	400
LP100-020	2	100	0
LP100-030	3	60	0
LP100-040	4	25	0
LP100-060	6	5	0
LP100-080	8	8	0
LP100-100	10	8	0
LP100-120	12	2	0

PIPE INCREASER-REDUCER (H×H)

Part Number	Size (in)	Std Pk	Mstr Ctn
LP102-212	1-1/2x1-1/4	25	150
LP102-251	2x1-1/2	25	100
LP102-337	3x1-1/2	25	0
LP102-338	3x2	20	80
LP102-419	4x1-1/2	25	0
LP102-420	4x2	10	40
LP102-422	4x3	20	0
LP102-532	6x4	6	0
LP102-582	8x4	12	0
LP102-585	8x6	12	0
LP102-624	10x4	12	0
LP102-626	10x6	12	0
LP102-628	10x8	10	0
LP102-668	12x8	2	0
LP102-670	12x10	2	0

FEMALE ADAPTER (FPT×H)

Part Number	Size (in)	Std Pk	Mstr Ctn
LP101-012	1-1/4	100	400
LP101-015	1-1/2	100	400
LP101-020	2	50	200
LP101-030	3	35	0
LP101-040	4	10	40
LP101-060	6	10	0
LP101-080	8	9	0

FEMALE ADAPTER (FPT×H)

Part Number	Size (in)	Std Pk	Mstr Ctn
LP101-212	1-1/2x1-1/4	100	400

TRAP ADAPTER-MALE (S×SLIP)

Part Number	Size (in)	Std Pk	Mstr Ctn
LP103-012	1-1/4	60	240
LP103-015	1-1/2	50	200
LP103-020	2	25	150
LP103-212	1-1/2x1-1/4	50	200

TRAP ADAPTER-MALE W/PLASTIC NUT (S×SLIP)

Part Number	Size (in)	Std Pk	Mstr Ctn
LP103P-012	1-1/4	30	180
LP103P-015	1-1/2	50	300
LP103P-020	2	25	100
LP103P-212	1-1/2x1-1/4	75	300

TRAP ADAPTER-MALE W/1-1/2 PLASTIC NUT & WASHER AND 1-1/2 x 1-1/4 WASHER (S×SLIP)

Part Number	Size (in)	Std Pk	Mstr Ctn
LP103R-015	1-1/2	10	80

TRAP ADAPTER-MALE W/PLASTIC NUT & WASHER (S×SLIP)

Part Number	Size (in)	Std Pk	Mstr Ctn
LP103X-012	1-1/4	30	180
LP103X-015	1-1/2	50	300
LP103X-020	2		
LP103X-212	1-1/2x1-1/4	50	300

PVC DWV FITTINGS



TRAP ADAPTER - FEMALE (H×SLIP)

Part Number	Size (in)	Std PK	Mstr Ctn
LP104-012	1-1/4	50	300
LP104-015	1-1/2	50	200
LP104-212	1-1/2x1-1/4	50	200
LP104-020	2	50	200

TRAP ADAPTER - FEMALE W/PLASTIC NUT (H×SLIP)

Part Number	Size (in)	Std PK	Mstr Ctn
LP104P-012	1-1/4		
LP104P-015	1-1/2	50	300
LP104P-212	1-1/2x1-1/4		
LP104P-020	2	50	200

TRAP ADAPTER-FEMALE W/1-1/2 PLASTIC NUT & WASHER AND 1-1/2x1-1/4 WASHER (H×SLIP)

Part Number	Size (in)	Std PK	Mstr Ctn
LP104R-015	1-1/2	50	200

TRAP ADAPTER-FEMALE W/PLASTIC NUT & WASHER (H×SLIP)

Part Number	Size (in)	Std PK	Mstr Ctn
LP104X-012	1-1/4		
LP104X-015	1-1/2	50	200
LP104X-212	1-1/2x1-1/4	50	300
LP104X-020	2		

FITTING CLEANOUT ADAPTER (S×FPT)

Part Number	Size (in)	Std PK	Mstr Ctn
LP105-012	1-1/4	35	210
LP105-015	1-1/2	50	200
LP105-020	2	50	200
LP105-030	3	20	80
LP105-040	4	10	40
LP105-060	6	10	0

FITTING CLEANOUT ADAPTER W/ C.O. PLUG (S×FPT)

Part Number	Size (in)	Std PK	Mstr Ctn
LP105X-012	1-1/4		
LP105X-015	1-1/2	50	200
LP105X-020	2	50	200
LP105X-030	3	20	80
LP105X-040	4	10	40
LP105X-060	6	6	0

CLEANOUT PLUG (MPT)

Part Number	Size (in)	Std PK	Mstr Ctn
LP106-012	1-1/4	50	600
LP106-015	1-1/2	50	300
LP106-020	2	50	200
LP106-030	3	25	150
LP106-040	4	30	120
LP106-060	6	10	40
LP106-080	8	5	20

CLEANOUT PLUG W/GASKET (MPT)

Part Number	Size (in)	Std PK	Mstr Ctn
LP106R-015	1-1/2	100	600
LP106R-020	2	50	200
LP106R-030	3	25	150
LP106R-040	4	25	100
LP106R-060	6	10	40

FLUSH BUSHING (S×H)

Part Number	Size (in)	Std PK	Mstr Ctn
LP107-212	1-1/2x1-1/4	100	400
LP107-250	2x1-1/4	50	200
LP107-251	2x1-1/2	50	200
LP107-337	3x1-1/2	30	120
LP107-338	3x2	30	120
LP107-420	4x2	30	0
LP107-422	4x3	30	0
LP107-530	6x3	10	0
LP107-532	6x4	10	0
LP107-582	8x4	3	0
LP107-585	8x6	3	0
LP107-626	10x6	12	0
LP107-628	10x8	9	0
LP107-666	12x6	4	0
LP107-668	12x8	4	0
LP107-670	12x10	4	0

PVC DWV FITTINGS



REDUCER BUSHING (DISHWASHER BUSHING) (S×FPT)

Part Number	Size (in)	Std PK	Mstr Ctn
LP108-209	1-1/2x1/2	50	300
LP108-210	1-1/2x3/4	50	300
LP108-212	1-1/2x1-1/4	50	400
LP108-251	2x1-1/2	50	200
LP108-337	3x1-1/2	10	60
LP108-338	3x2	10	60
LP108-628	10x8	12	0
LP108-668	12x8	4	0

MALE ADAPTER (MPT×H)

Part Number	Size (in)	Std PK	Mstr Ctn
LP109-012	1-1/4	50	200
LP109-015	1-1/2	50	300
LP109-020	2	50	200
LP109-030	3	25	0
LP109-040	4	25	0
LP109-060	6	7	0
LP109-169	1-1/4x1-1/2	25	150

FLUSH C. O. PLUG (MPT)

Part Number	Size (in)	Std PK	Mstr Ctn
LP110-020	2	50	400
LP110-030	3	25	150
LP110-040	4	25	150

PLUG SLIP (S)

Part Number	Size (in)	Std PK	Mstr Ctn
LP110S-015	1-1/2	25	300
LP110S-020	2	50	200

TRAP ADAPTER CAP (FPT)

Part Number	Size (in)	Std PK	Mstr Ctn
LP112-012	1-1/4		
LP112-015	1-1/2		
LP112-020	2		

TRAP ADAPTER CAP B (FPT)

Part Number	Size (in)	Std PK	Mstr Ctn
LP113-012	1-1/4		
LP113-015	1-1/2		

TRAP ADAPTER Gasket

Part Number	Size (in)	Std PK	Mstr Ctn
LP113R-012	1-1/4		
LP113R-015	1-1/2		

TRAP ADAPTER CAP W/GASKET

Part Number	Size (in)	Std PK	Mstr Ctn
LP114-012	1-1/4	50	200
LP114-015	1-1/2	50	200

CAP (SOC)

Part Number	Size (in)	Std PK	Mstr Ctn
LP116-015	1-1/2	20	240
LP116-020	2	15	180
LP116-030	3	10	60
LP116-040	4	5	20
LP116-060	6	8	0
LP116-080	8	16	0
LP116-100	10	16	0
LP116-120	12	4	0

ADAPTER COUPLING (H×H)

Part Number	Size (in)	Std PK	Mstr Ctn
LP117-030	3	35	0
LP117-040	4	20	0
LP117-422	4x3	12	48

Adapts Sewer & Drain Pipe to DWV Pipe.

PVC DWV FITTINGS



ADAPTER COUPLING (S/D S×DWV H)

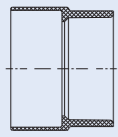

Part Number	Size (in)	Std PK	Mstr Ctn
LP117X-422	4x3	8	48

ADAPTER BUSHING (DWV SPIGOT×HUB)



Part Number	Size (in)	Std PK	Mstr Ctn
LP118-020	2	25	300
LP118-030	3	25	150
LP118-040	4	10	60
LP118-060	6	12	0

NO-HUB ADAPTER (S×H)

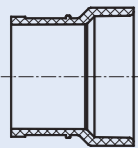

Part Number	Size (in)	Std PK	Mstr Ctn
LP119-015	1-1/2	25	100
LP119-020	2	25	100
LP119-030	3	20	80
LP119-040	4	14	56
LP119-251	2x1-1/2	25	100
LP119-422	4x3	8	48

HUB ADAPTER (H×S)

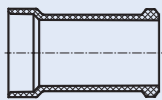

Part Number	Size (in)	Std PK	Mstr Ctn
LP123-020	2	20	80
LP123-030	3	20	0
LP123-040	4	12	0

TRAP ADAPTER PLUG (H×NPSM THREAD)

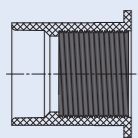

Part Number	Size (in)	Std PK	Mstr Ctn
LP128-015	1-1/2	20	80

TRAP ADAPTER PLUG (S×NPSM THREAD)

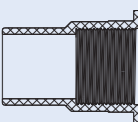

Part Number	Size (in)	Std PK	Mstr Ctn
LP129-015	1-1/2	12	72

REPAIR COUPLING (H×H)



Part Number	Size (in)	Std PK	Mstr Ctn
LP130-015	1-1/2	100	400
LP130-020	2	30	120
LP130-030	3	10	60
LP130-040	4	5	30
LP130-060	6	12	0

TEST CAP (S)



Part Number	Size (in)	Std PK	Mstr Ctn
LP131-015	1-1/2	100	600
LP131-020	2	100	600
LP131-030	3	50	200
LP131-040	4	100	400

THREADED CAP (FPT)

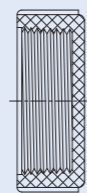

Part Number	Size (in)	Std PK	Mstr Ctn
LP135-015	1-1/2	50	400
LP135-020	2	35	210
LP135-030	3	30	120

90° ELBOW-SHORT TURN (H×H)

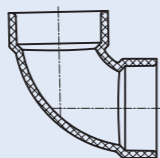

Part Number	Size (in)	Std PK	Mstr Ctn
LP300-015S	1-1/2	100	0
LP300-020S	2	25	100
LP300-030S	3	25	0

1/4 BEND (H×H)

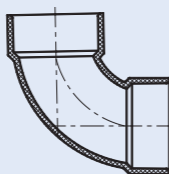

Part Number	Size (in)	Std PK	Mstr Ctn
LP300-012	1-1/4	50	200
LP300-015	1-1/2	100	0
LP300-020	2	50	0
LP300-030	3	25	0
LP300-040	4	10	0
LP300-060	6	4	0
LP300-080	8	4	0

PVC DWV FITTINGS



1/4 BEND, REDUCING (H×H)

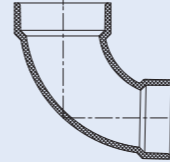

Part Number	Size (in)	Std PK	Mstr Ctn
LP300R-251	2x1-1/2	50	0

90° ELBOW-SHORT TURN (H×S)

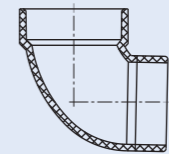

Part Number	Size (in)	Std PK	Mstr Ctn
LP302-020S	2	70	0

1/4 BEND WITH SIDE INLET (ALL HUB)

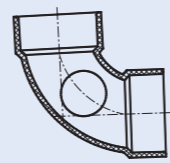

Part Number	Size (in)	Std PK	Mstr Ctn
LP300S-337	3x3x1-1/2	8	0
LP300S-338	3x3x2	10	0

1/4 BEND W/ LOW HEEL INLET (H×H×H)

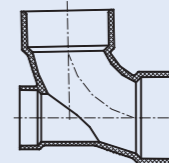

Part Number	Size (in)	Std PK	Mstr Ctn
LP303-337	3x3x1-1/2	25	0
LP303-338	3x3x2	25	0
LP303-420	4x4x2	6	0

90° TRAP ADAPTER (H×SLIP)

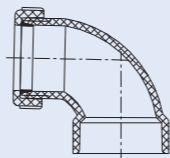

Part Number	Size (in)	Std PK	Mstr Ctn
LP300X-015	1-1/2		

LONG SWEEP 1/4 BEND (H×H)

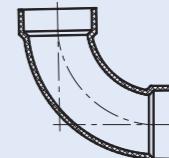

Part Number	Size (in)	Std PK	Mstr Ctn
LP304-015	1-1/2	30	120
LP304-020	2	15	60
LP304-030	3	10	0
LP304-040	4	5	0
LP304-060	6	4	0

1/4 BEND (H X FPT)

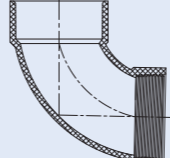

Part Number	Size (in)	Std PK	Mstr Ctn
LP301-030	3	15	0

11-1/4° ELBOW (H×H)

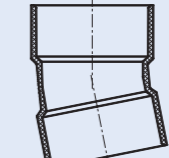

Part Number	Size (in)	Std PK	Mstr Ctn
LP305-060	6	6	0

1/4 BEND, STREET (S×H)

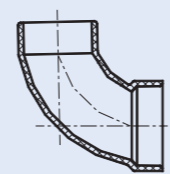

Part Number	Size (in)	Std PK	Mstr Ctn
LP302-012	1-1/4	50	200
LP302-015	1-1/2	30	180
LP302-020	2	50	0
LP302-030	3	20	0
LP302-040	4	10	0
LP302-060	6	4	0
LP302-080	8	4	0

11-1/4° ELBOW (S×H)

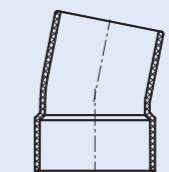

Part Number	Size (in)	Std PK	Mstr Ctn
LP306-060	6	5	0

PVC DWV FITTINGS



LONG SWEEP 1/4 BEND W/LOW HEEL INLET (ALL HUB)

Part Number	Size (in)	Std PK	Mstr Ctn
LP307-337	3x3x1-1/2	10	0
LP307-338	3x3x2	20	0

LONG SWEEP 1/4 BEND W/HIGH HEEL INLET (ALL HUB)

Part Number	Size (in)	Std PK	Mstr Ctn
LP308-338	3x3x2	20	0

LONG SWEEP 1/4 BEND, STREET (H×S)

Part Number	Size (in)	Std PK	Mstr Ctn
LP309-015	1-1/2	30	120
LP309-020	2	15	60
LP309-030	3	10	0
LP309-040	4	5	0

1/4 BEND, STREET W/ LOW HEEL INLET (H×S×H)

Part Number	Size (in)	Std PK	Mstr Ctn
LP310-338	3x3x2	15	0

LONG SWEEP 1/4 BEND W/SIDE INLET (ALL HUB)

Part Number	Size (in)	Std PK	Mstr Ctn
LP311-338	3x3x2	10	0

1/6 BEND (H×H)

Part Number	Size (in)	Std PK	Mstr Ctn
LP319-015	1-1/2	40	160
LP319-020	2	25	100
LP319-030	3	20	0
LP319-040	4	8	0
LP319-060	6	2	0

1/6 BEND, STREET (H×S)

Part Number	Size (in)	Std PK	Mstr Ctn
LP320-015	1-1/2	40	160
LP320-020	2	25	100
LP320-030	3	20	0
LP320-040	4	10	0

1/8 BEND (H×H)

Part Number	Size (in)	Std PK	Mstr Ctn
LP321-012	1-1/4	50	200
LP321-015	1-1/2	100	0
LP321-020	2	50	0
LP321-030	3	25	0
LP321-040	4	15	0
LP321-060	6	5	0
LP321-080	8	4	0

45° ELBOW-SHORT TURN (H×H)

Part Number	Size (in)	Std PK	Mstr Ctn
LP321-015S	1-1/2	60	240

1/8 BEND, STREET (H×S)

Part Number	Size (in)	Std PK	Mstr Ctn
LP323-012	1-1/4	40	240
LP323-015	1-1/2	100	0
LP323-020	2	50	0
LP323-030	3	25	0
LP323-040	4	9	0
LP323-060	6	5	0
LP323-080	8	4	0
LP323-100	10	4	0

PVC DWV FITTINGS



45° ELBOW-SHORT TURN (H×S)

Part Number	Size (in)	Std PK	Mstr Ctn
LP323-015S	1-1/2	80	320

1/16 BEND (H×H)

Part Number	Size (in)	Std PK	Mstr Ctn
LP324-015	1-1/2	50	200
LP324-020	2	25	100
LP324-030	3	25	0
LP324-040	4	15	0
LP324-060	6	3	0
LP324-080	8	6	0
LP324-100	10	4	0
LP324-120	12	2	0

22-1/2° ELBOW-SHORT TURN (H×H)

Part Number	Size (in)	Std PK	Mstr Ctn
LP324-015S	1-1/2	50	200

1/16 BEND, STREET (H×S)

Part Number	Size (in)	Std PK	Mstr Ctn
LP326-015	1-1/2	50	200
LP326-020	2	25	100
LP326-030	3	25	0
LP326-040	4	10	0
LP326-060	6	5	0

DOUBLE 1/4 BEND (H×H×H)

Part Number	Size (in)	Std PK	Mstr Ctn
LP327-015	1-1/2	20	80
LP327-020	2	25	0
LP327-030	3	15	0
LP327-040	4	6	0
LP327-241	2x1-1/2x1-1/2	15	60

CLOSET BEND, REDUCING (H×H)

Part Number	Size (in)	Std PK	Mstr Ctn
LP329-342	3x4	10	0

VENT ELL (H×H)

Part Number	Size (in)	Std PK	Mstr Ctn
LP331-012	1-1/4	30	120
LP331-015	1-1/2	25	150
LP331-020	2	30	120
LP331-030	3	25	0
LP331-040	4	10	0
LP331-060	6	4	0

VENT ELL, STREET (H×S)

Part Number	Size (in)	Std PK	Mstr Ctn
LP333-012	1-1/4	30	120
LP333-015	1-1/2	25	150
LP333-020	2	20	80
LP333-030	3	25	0
LP333-040	4	10	0
LP333-060	6	4	0
LP333-080	8	4	0
LP333-100	10	2	0

TRAP ELBOW (FOR USE WITH TRAPS ONLY) (H×S)

Part Number	Size (in)	Std PK	Mstr Ctn
LP335-030	3	30	0
LP335-040	4	20	0

PVC DWV FITTINGS



SANITARY TEE (ALL HUB)

Part Number	Size (in)	Std PK	Mstr Ctn
LP400-012	1-1/4	50	0
LP400-015	1-1/2	60	0
LP400-020	2	35	0
LP400-030	3	15	0
LP400-040	4	5	0
LP400-060	6	3	0
LP400-080	8	2	0

REDUCING SANITARY TEE (ALL HUB)

Part Number	Size (in)	Std PK	Mstr Ctn
LP401-212	1-1/2x1-1/2x1-1/4	10	40
LP401-241	2x1-1/2x1-1/2	15	60
LP401-251	2x2x1-1/2	50	0
LP401-257	2x1-1/2x2	15	60
LP401-337	3x3x1-1/2	8	32
LP401-338	3x3x2	15	0
LP401-419	4x4x1-1/2	10	0
LP401-420	4x4x2	10	0
LP401-422	4x4x3	10	0
LP401-528	6x6x2	5	0
LP401-530	6x6x3	4	0
LP401-532	6x6x4	4	0

SANITARY TEE, STREET (S×H×H)

Part Number	Size (in)	Std PK	Mstr Ctn
LP403-015	1-1/2	25	100
LP403-020	2	30	0
LP403-030	3	10	0
LP403-040	4	10	0

SANITARY TEE, STREET REDUCING (S×H×H)

Part Number	Size (in)	Std PK	Mstr Ctn
LP404-241	2x1-1/2x1-1/2	50	0
LP404-251	2x2x1-1/2	15	60
LP404-257	2x1-1/2x2	15	60
LP404-337	3x3x1-1/2	9	36
LP404-338	3x3x2	15	0
LP404-420	4x4x2	10	0

SANITARY TEE W/ LEFT SIDE INLET (ALL HUB)

Part Number	Size (in)	Std PK	Mstr Ctn
LP416-337	3x3x3x1-1/2	8	0
LP416-338	3x3x3x2	10	0
LP416-420	4x4x4x2	4	0

SANITARY TEE W/ RIGHT SIDE INLET (ALL HUB)

Part Number	Size (in)	Std PK	Mstr Ctn
LP417-337	3x3x3x1-1/2	10	0
LP417-338	3x3x3x2	12	0
LP417-420	4x4x4x2	8	0

SANITARY TEE W/ R & L SIDE INLETS (ALL HUB)

Part Number	Size (in)	Std PK	Mstr Ctn
LP418-337	3x3x3x1-1/2x1-1/2	6	0
LP418-338	3x3x3x2x2	6	0
LP418-420	4x4x4x2x2	5	0

PVC DWV FITTINGS



OFFSET CLOSET FLANGE W/ ADJUSTABLE METAL RING (EPOXY COATED)(H)

Part Number	Size (in)	Std PK	Mstr Ctn
LP820-422	4x3	24	0
LP820-040	4x4	16	0

CLOSET FLANGE W/ ADJUSTABLE W/ PVC PLASTIC RING

Part Number	Size (in)	Std PK	Mstr Ctn
LP820P-422	4x3	24	0

DOUBLE SANITARY TEE (ALL HUB)

Part Number	Size (in)	Std PK	Mstr Ctn
LP428-015	1-1/2	15	60
LP428-020	2	25	0
LP428-030	3	6	0
LP428-040	4	6	0
LP428-060	6	1	0

DOUBLE SANITARY TEE, REDUCING (ALL HUB)

Part Number	Size (in)	Std PK	Mstr Ctn
LP429-251	2x2x1-1/2x1-1/2	25	0
LP429-323	3x3x2x1-1/2	25	0
LP429-337	3x3x1-1/2x1-1/2	6	24
LP429-338	3x3x2x2	10	0
LP429-419	4x4x1-1/2x1-1/2	7	0
LP429-420	4x4x2x2	5	0
LP429-422	4x4x3x3	5	0
LP429-528	6x6x2x2	4	0
LP429-530	6x6x3x3	4	0
LP429-532	6x6x4x4	3	0

DOUBLE SANITARY TEE, STREET, REDUCING (S×H×H×H)

Part Number	Size (in)	Std PK	Mstr Ctn
LP431-338	3x3x2x2	10	0

DOUBLE SANITARY TEE, W/SIDE INLET (ALL HUB)

Part Number	Size (in)	Std PK	Mstr Ctn
LP438-337	3x3x3x3x1-1/2	5	0
LP438-338	3x3x3x3x2	5	0
LP438-420	4x4x4x4x2	4	0

DOUBLE SANITARY TEE W/ R&L SIDE INLETS (ALL HUB)

Part Number	Size (in)	Std PK	Mstr Ctn
LP439-338	3x3x3x3x2x2		
LP439-420	4x4x4x4x2x2	4	0

VENT TEE (ALL HUB)

Part Number	Size (in)	Std PK	Mstr Ctn
LP441-015	1-1/2	25	100
LP441-020	2	25	0
LP441-030	3	10	0
LP441-040	4	5	0
LP441-060	6	3	0
LP441-080	8	5	0

CLEANOUT TEE W/ C.O. PLUG (H×H)

Part Number	Size (in)	Std PK	Mstr Ctn
LP444X-015	1-1/2	20	80
LP444X-020	2	15	60
LP444X-030	3	20	0
LP444X-040	4	10	0
LP444X-060	6	4	0
LP444X-080	8	4	0

PVC DWV FITTINGS



FLUSH C.O. TEE (H×H×FPT)

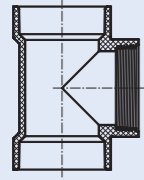

Part Number	Size (in)	Std PK	Mstr Ctn
LP445-015	1-1/2	20	120
LP445-020	2	20	80
LP445-030	3	15	0
LP445-040	4	10	0
LP445-060	6	6	0
LP445-080	8	4	0

FLUSH C.O. TEE W/C. O. PLUG (H×H×FPT)

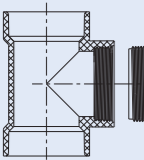

Part Number	Size (in)	Std PK	Mstr Ctn
LP445X-020	2	10	60
LP445X-030	3		
LP445X-040	4	10	0

2-WAY CLEANOUT (ALL HUB)

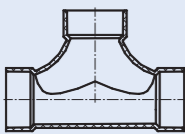

Part Number	Size (in)	Std PK	Mstr Ctn
LP448-030	3	10	0
LP448-040	4	4	0

DOUBLE FIXTURE FITTING (ALL HUB)

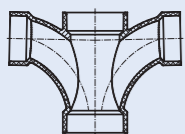

Part Number	Size (in)	Std PK	Mstr Ctn
LP500-020	2x2x2x2	15	0
LP500-030	3x3x3x3	10	0
LP500-241	2x1-1/2x1-1/2x1-1/2	20	0
LP500-251	2x2x1-1/2x1-1/2	20	0
LP500-257	2x1-1/2x2x2	20	0
LP500-338	3x2x3x3	10	0

COMBINATION WYE AND 1/8 BEND (ONE PIECE) (ALL HUB)

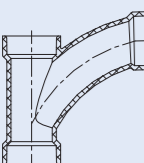

Part Number	Size (in)	Std PK	Mstr Ctn
LP501-015	1-1/2	10	40
LP501-020	2	20	0
LP501-030	3	10	0
LP501-040	4	4	0

COMBINATION WYE AND 1/8 BEND, REDUCING (ONE PIECE) (ALL HUB)

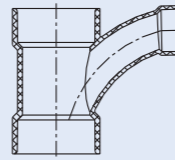

Part Number	Size (in)	Std PK	Mstr Ctn
LP502-241	2x1-1/2x1-1/2	10	40
LP502-251	2x2x1-1/2	10	40
LP502-257	2x1-1/2x2	20	0
LP502-337	3x3x1-1/2	12	0
LP502-338	3x3x2	12	0
LP502-420	4x4x2	6	0
LP502-422	4x4x3	4	0

COMBINATION WYE AND 1/8 BEND (TWO PIECE) (ALL HUB)

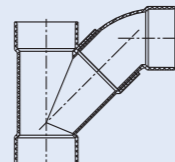

Part Number	Size (in)	Std PK	Mstr Ctn
LP503-015	1-1/2		
LP503-020	2		
LP503-030	3	10	0
LP503-040	4	5	0
LP503-060	6	1	0
LP503-080	8	1	0

COMBINATION WYE AND 1/8 BEND, REDUCING (TWO PIECE) (ALL HUB)

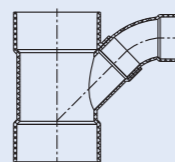

Part Number	Size (in)	Std PK	Mstr Ctn
LP504-338	3x3x2		
LP504-422	4x4x3		
LP504-532	6x6x4	3	0
LP504-582	8x8x4	2	0
LP504-585	8x8x6	2	0
LP504-624	10x10x4	2	0

COMBINATION WYE AND 1/8 BEND DOUBLE ASSEMBLY (ALL HUB)

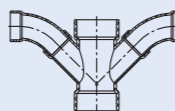

Part Number	Size (in)	Std PK	Mstr Ctn
LP507-015	1-1/2		
LP507-020	2		
LP507-030	3	6	0
LP507-040	4	3	0
LP507-251	2x1-1/2	30	0
LP507-338	3x2	10	0
LP507-420	4x2	5	0
LP507-422	4x3	5	0

PVC DWV FITTINGS



COMBINATION WYE AND 1/8 BEND W/LEFT SIDE INLET (ALL HUB)

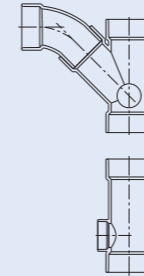

Part Number	Size (in)	Std PK	Mstr Ctn
LP515-338	3x3x3x2		

COMBINATION WYE AND 1/8 BEND W/RIGHT SIDE INLET (ALL HUB)

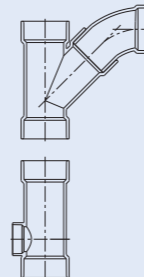

Part Number	Size (in)	Std PK	Mstr Ctn
LP516-338	3x3x3x2		

WYE (ALL HUB)

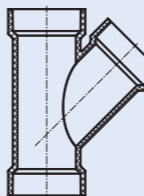

Part Number	Size (in)	Std PK	Mstr Ctn
LP600-012	1-1/4	25	100
LP600-015	1-1/2	50	0
LP600-020	2	25	0
LP600-030	3	15	0
LP600-040	4	8	0
LP600-060	6	2	0
LP600-080	8	2	0

DISHWASHER WYE(H X H X HOSE BARB)

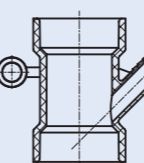

Part Number	Size (in)	Std PK	Mstr Ctn
LP601-209	1-1/2x1-1/2x1/2	40	160

REDUCING WYE (ALL HUB)

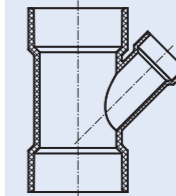

Part Number	Size (in)	Std PK	Mstr Ctn
LP601-241	2x1-1/2x1-1/2	15	60
LP601-251	2x2x1-1/2	15	60
LP601-257	2x1-1/2x2	10	40
LP601-337	3x3x1-1/2	15	0
LP601-338	3x3x2	12	0
LP601-419	4x4x1-1/2	10	0
LP601-420	4x4x2	10	0
LP601-422	4x4x3	10	0
LP601-528	6x6x2	5	0
LP601-530	6x6x3	3	0
LP601-532	6x6x4	4	0
LP601-582	8x8x4	4	0
LP601-585	8x8x6	2	0
LP601-624	10x10x4	4	0

WYE, STREET (S×H×H)

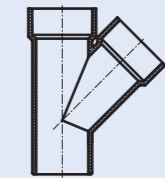

Part Number	Size (in)	Std PK	Mstr Ctn
LP602-015	1-1/2		
LP602-020	2	10	40
LP602-030	3	10	0
LP602-040	4	8	0

WYE, STREET, REDUCING (S×H×H)

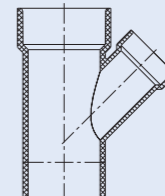

Part Number	Size (in)	Std PK	Mstr Ctn
LP603-251	2x2x1-1/2	15	60
LP603-337	3x3x1-1/2	15	0
LP603-338	3x3x2	8	0
LP603-420	4x4x2	5	0
LP603-422	4x4x3	5	0

DOUBLE WYE (ALL HUB)

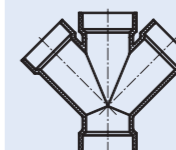

Part Number	Size (in)	Std PK	Mstr Ctn
LP611-015	1-1/2	40	0
LP611-020	2	20	0
LP611-030	3	8	0
LP611-040	4	5	0
LP611-060	6	1	0

PVC DWV FITTINGS



DOUBLE WYE, W/2" SIDE INLET (ALL HUB)

Part Number	Size (in)	Std PK	Mstr Ctn
LP611S-030	3x3x3x3x2	10	0

REDUCING DOUBLE WYE (ALL HUB)

Part Number	Size (in)	Std PK	Mstr Ctn
LP612-251	2x2x1-1/2x1-1/2	10	40
LP612-337	3x3x1-1/2x1-1/2	10	0
LP612-338	3x3x2x2	15	0
LP612-420	4x4x2x2	6	0
LP612-422	4x4x3x3	5	0
LP612-528	6x6x2x2	4	0
LP612-530	6x6x3x3	3	0
LP612-532	6x6x4x4	3	0

WYE W/LEFT SIDE INLET (ALL HUB)

Part Number	Size (in)	Std PK	Mstr Ctn
LP625-338	3x3x3x2	18	0
LP625-420	4x4x4x2	4	0

WYE W/RIGHT SIDE INLET (ALL HUB)

Part Number	Size (in)	Std PK	Mstr Ctn
LP626-338	3x3x3x2	6	0
LP626-420	4x4x4x2	3	0

RETURN BEND (H×H)

Part Number	Size (in)	Std PK	Mstr Ctn
LP700-015	1-1/2	20	80
LP700-020	2	25	0
LP700-030	3	8	0
LP700-040	4	6	0
LP700-060	6	2	0

ADAPTER, TAIL PIECE BODY W/PLASTIC NUT (SPG×MIPT)

Part Number	Size (in)	Std PK	Mstr Ctn
LP704-015	1-1/2	24	144

ADAPTER, TAIL PIECE W/PLASTIC NUT (S×SLIP)

Part Number	Size (in)	Std PK	Mstr Ctn
LP704P-015	1-1/2	24	144
LP704P-212	1-1/2x1-1/4	20	120

P-TRAP (H×H)

Part Number	Size (in)	Std PK	Mstr Ctn
LP706X-015	1-1/2	25	0
LP706X-020	2	15	0
LP706X-030	3	10	0
LP706X-040	4	4	0
LP706X-060	6	1	0

P-TRAP W/ CLEANOUT (H×H)

Part Number	Size (in)	Std PK	Mstr Ctn
LP707X-015	1-1/2	30	0
LP707X-020	2	20	0

ADJUSTABLE P-TRAP W/ PLASTIC NUT (H×H)

Part Number	Size (in)	Std PK	Mstr Ctn
LP708P-012	1-1/4	30	0
LP708P-015	1-1/2	30	0
LP708P-020	2	20	0

PVC DWV FITTINGS



P-TRAP W/UNION JOINT (H x FPT)

Part Number	Size (in)	Std PK	Mstr Ctn
LP709-015	1-1/2	30	0

P-TRAP, LOW PROFILE (H×H)

Part Number	Size (in)	Std PK	Mstr Ctn
LP710-015	1-1/2	25	0
LP710-020	2	15	0
LP710-030	3	10	0
LP710-040	4	4	0
LP710-060	6	1	0

L.A. PATTERN P-TRAP ,W/UNION & 1-1/2 & 1-1/4 SLIP WASHERS ,W/PLASTIC NUT (SLIP×H)

Part Number	Size (in)	Std PK	Mstr Ctn
LP711P-169	1-1/4x1-1/2	30	0
LP711P-015	1-1/2	30	0

P-TRAP (H×SLIP)

Part Number	Size (in)	Std PK	Mstr Ctn
LP713-015	1-1/2		

WASHER BOX P-TRAP (H×H)

Part Number	Size (in)	Std PK	Mstr Ctn
LP716-020	2		

CLOSET FLANGE (H)

Part Number	Size (in)	Std PK	Mstr Ctn
LP800-040	4x4	30	0
LP800-422	4x3	25	0

CLOSET FLANGE W/TEST PLATE(H)

Part Number	Size (in)	Std PK	Mstr Ctn
LP800T-422	4x3	20	0

CLOSET FLANGE, REDUCING (SPIGOT)

Part Number	Size (in)	Std PK	Mstr Ctn
LP801-422	4x3	25	0

CLOSET FLANGE W/ADJUSTABLE METAL RING (EPOXY COATED)(H)

Part Number	Size (in)	Std PK	Mstr Ctn
LP811-422	4x3	20	0
LP811-040	4x4	20	0

CLOSET FLANGE W/ADJUSTABLE METAL RING (EPOXY COATED)(S)

Part Number	Size (in)	Std PK	Mstr Ctn
LP812-422	4x3	36	0
LP812-040	4x4	30	0

CLOSET FLANGE W/ ADJUSTABLE PLASTIC RING (S)

Part Number	Size (in)	Std PK	Mstr Ctn
LP812P-422	4x3	25	0

PVC DWV FITTINGS



OFFSET CLOSET FLANGE W/ADJUSTABLE METAL RING (EPOXY COATED)(H)

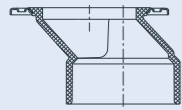

Part Number	Size (in)	Std PK	Mstr Ctn
LP820-422	4x3	24	0
LP820-040	4x4	16	0

CLOSET FLANGE (FPT)

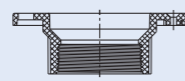

Part Number	Size (in)	Std PK	Mstr Ctn
LP830-422	4x3	20	0

OFFSET CLOSET FLANGE W/ADJUSTABLE PLASTIC RING (H)

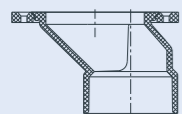

Part Number	Size (in)	Std PK	Mstr Ctn
LP820P-422	4x3	24	0

CLOSET FLANGE (MPT)

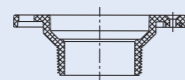

Part Number	Size (in)	Std PK	Mstr Ctn
LP831-422	4x3	25	0

TUBE END CLEANOUT (H×GASLET PLUG)

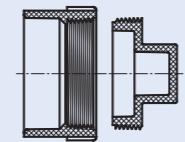

Part Number	Size (in)	Std PK	Mstr Ctn
LP905X-015	1-1/2	25	150
LP905X-020	2	25	100
LP905X-030	3	20	80
LP905X-040	4	24	0

Fitting Terms and Abbreviations:

- H/HUB: Solvent Weld Socket
- S: Spigot End (pipe O.D. size)
- FPT: Female Iron Pipe Thread
- MPT: Male Iron Pipe Thread
- NPSM: Straight Thread for Mechanical Joint
- SLIP: Trap End for Receiving Drain Tail Piece
- W/: with
- C.O.: Cleanout
- S/D: Sewer&Drain
- L.A.: Los Angeles

Note: Polyethylene Test Cap Series in PVC DWV is the Same as the one in ABS DWV

ABS DWV Fittings

QUALITY

LESSO America's plastic fittings line is renowned worldwide for its superior quality, which complies with cNSFus certification, and exceeds the requirements of ASTM standards and CSA standards.

REFERENTIAL STANDARDS

ASTM D3965

Standard Classification System and Basis for Specifications for Rigid Acrylonitrile-Butadiene-Styrene (ABS) Materials for Pipe and Fittings

ASTM D2661

Standard Specification for Acrylonitrile-Butadiene-Styrene (ABS) Schedule 40 Plastic Drain, Waste, and Vent Pipe and Fittings

CSA B181.1

Acrylonitrile-Butadiene-Styrene (ABS) Drain, Waste, and Vent Pipe and pipe fittings



Column Header Information

Each product column header label identifies the following product particulars:

Part Number: the number used to order the part.

Size: nominal diameter of pipe with which the fitting is to be used.

NOTE: Fittings may be same size (only one size designation) or reducing (multiple sizes designated).

Standard Pack (Std Pk) the quantity of parts packaged in an individual box or bag.

Methods of Designating Inlets of Fittings

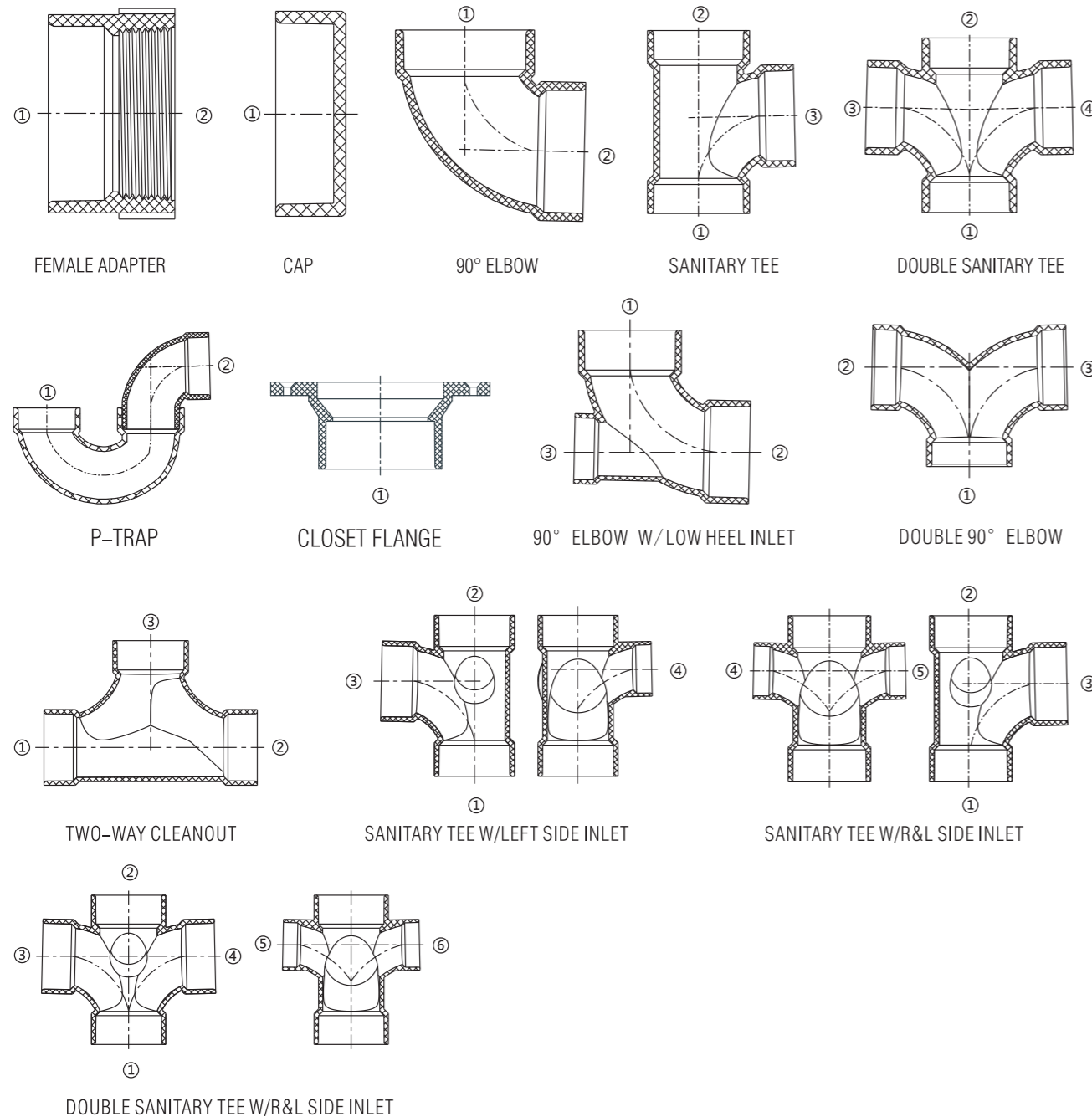

ABS DWV Fittings



COUPLING (HUB x HUB)



Part Number	Size (in)	Std PK
LN100-012	1-1/4	125
LN100-015	1-1/2	125
LN100-020	2	100
LN100-030	3	45
LN100-040	4	25
LN100-060	6	12

TRAP ADAPTER W/PLASTIC NUT&WASHER (SPGX SJ)

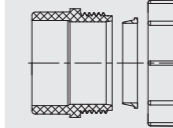

Part Number	Size (in)	Std PK
LN103X-012	1-1/4	
LN103X-015	1-1/2	
LN103X-020	2	50
LN103X-212	1-1/2x1-1/4	

FEMALE ADAPTER (HUB x FIPT)

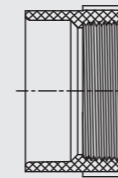

Part Number	Size (in)	Std PK
LN101-012	1-1/4	125
LN101-015	1-1/2	100
LN101-020	2	75
LN101-030	3	30
LN101-040	4	25
LN101-060	6	10

TRAP ADAPTER-FEMALE (HUB x SJ)

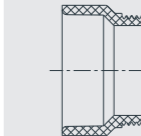

Part Number	Size (in)	Std PK
LN104-012	1-1/4	
LN104-015	1-1/2	
LN104-020	2	
LN104-212	1-1/2" x 1-1/4"	

PIPE INCREASER-REDUCER (HUB x HUB)



Part Number	Size (in)	Std PK
LN102-212	1-1/2x1-1/4	125
LN102-251	2x1-1/2	75
LN102-337	3x1-1/2	35
LN102-338	3x2	35
LN102-419	4x1-1/2	20
LN102-420L	4x2	10
LN102-422L	4x3	10

TRAP ADAPTER W/PLASTIC NUT (HUB x SJ)

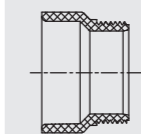

Part Number	Size (in)	Std PK
LN104P-012	1-1/4	125
LN104P-015	1-1/2	100
LN104P-212	1-1/2x1-1/4	100

TRAP ADAPTER (SPG x SJ)

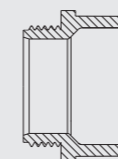

Part Number	Size (in)	Std PK
LN103-012	1-1/4"	
LN103-015	1-1/2"	
LN103-020	2	100
LN103-212	1-1/2"x1-1/4"	

TRAP ADAPTER W/PLASTIC NUT & WASHER (HUB x SJ)

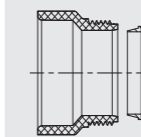

Part Number	Size (in)	Std PK
LN104X-012	1-1/4	
LN104X-015	1-1/2	
LN104X-020	2	50
LN104X-212	1-1/2x1-1/4	

TRAP ADAPTER W/PLASTIC NUT (SPG x SJ)

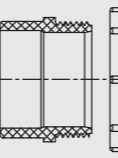

Part Number	Size (in)	Std PK
LN103P-012	1-1/4	100
LN103P-015	1-1/2	100
LN103P-212	1-1/2x1-1/4	100

CLEANOUT ADAPTER (SPG x FIPT)

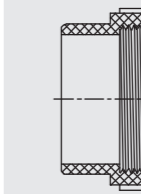

Part Number	Size (in)	Std PK
LN105-012	1-1/4	70
LN105-015	1-1/2	100
LN105-020	2	60
LN105-030	3	35
LN105-040	4	25
LN105-060	6	15

ABS DWV Fittings



CLEANOUT ADAPTER W/PLUG (SPG x CLEANOUT W/PLUG)

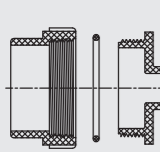

Part Number	Size (in)	Std PK
LN105X-012	1-1/4	110
LN105X-015	1-1/2	90
LN105X-020	2	50
LN105X-030	3	30
LN105X-040	4	25
LN105X-060	6	12

MALE ADAPTER (HUB x MIPT)

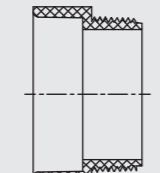

Part Number	Size (in)	Std PK
LN109-012	1-1/4	70
LN109-015	1-1/2	125
LN109-020	2	80
LN109-030	3	30
LN109-040	4	15
LN109-212	1-1/2x1-1/4	100

PLUG WITH GASKET (MIPT)

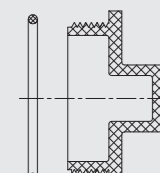

Part Number	Size (in)	Std PK
LN106R-012	1-1/4	100
LN106R-015	1-1/2	100
LN106R-020	2	150
LN106R-025	2-1/2	25
LN106R-030	3	25
LN106R-035	3-1/2	25
LN106R-040	4	35
LN106R-060	6	10

SLIP PLUG (SPG)

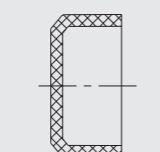

Part Number	Size (in)	Std PK
LN110S-015	1-1/2	100
LN110S-020	2	90

MALE ADAPTER (SPG x MIPT)

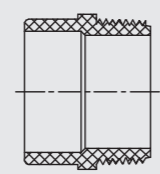

Part Number	Size (in)	Std PK
LN111-012	1-1/4	50
LN111-015	1-1/2	100
LN111-020	2	25
LN111-030	3	20
LN111-040	4	10
LN111-212	1-1/2x1-1/4	50

FLUSH BUSHING (SPG x HUB)

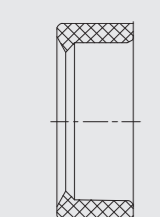

Part Number	Size (in)	Std PK
LN107-212	1-1/2x1-1/4	150
LN107-251	2x1-1/2	150
LN107-337	3x1-1/2	35
LN107-338	3x2	60
LN107-419	4x1-1/2	10
LN107-420	4x2	20
LN107-422	4x3	35
LN107-532	6x4	8

CAP (HUB)

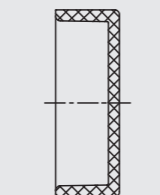

Part Number	Size (in)	Std PK
LN116-012	1-1/4	120
LN116-015	1-1/2	90
LN116-020	2	110
LN116-030	3	30
LN116-040	4	25
LN116-060	6	24

FLUSH ADAPTER (SPG x FIPT)

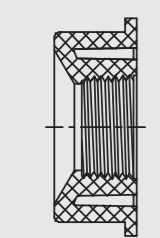

Part Number	Size (in)	Std PK
LN108-209	1-1/2x1/2	120
LN108-210	1-1/2x3/4	100
LN108-212	1-1/2x1-1/4	100
LN108-251	2x1-1/2	90
LN108-337	3x1-1/2	40
LN108-338	3x2	20
LN108-422	4x3	

SEWER & DRAIN ADAPTER (HUB x HUB)

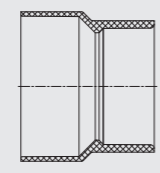

Part Number	Size (in)	Std PK
LN117-422	4x3	25

ABS DWV Fittings



ABS-COPPER ADAPTER (HUB x SJ)

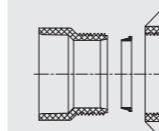

Part Number	Size (in)	Std PK
LN120-015	1-1/2	80
LN120-212	1-1/2x1-1/4	80

90° ELBOW (HUB x HUB)

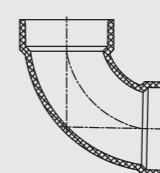

Part Number	Size (in)	Std PK
LN300-012	1-1/4	75
LN300-015	1-1/2	110
LN300-020	2	50
LN300-030	3	15
LN300-040	4	15
LN300-060	6	4

UNION (HUB x HUB)

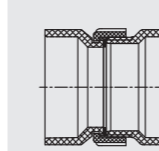

Part Number	Size (in)	Std PK
LN126-015	1-1/2	50
LN126-020	2	15

90° ELBOW-SHORT TURN (HUB x HUB)

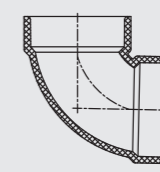

Part Number	Size (in)	Std PK
LN300-012S	1-1/4	70
LN300-015S	1-1/2	125
LN300-020S	2	50
LN300-030S	3	20
LN300-040S	4	20
LN300-060S	6	3

REPAIR COUPLING (HUB x HUB)

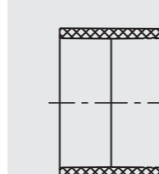

Part Number	Size (in)	Std PK
LN130-015	1-1/2	50
LN130-020	2	25
LN130-030	3	25
LN130-040	4	15

90° ELBOW WITH SIDE INLET (HUB x HUB x HUB)

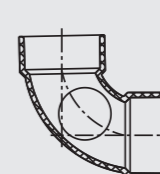

Part Number	Size (in)	Std PK
LN300S-337	3x3x1-1/2	20
LN300S-338	3x3x2	20

POLYETHYLENE TEST CAP



Part Number	Size (in)	Std PK
LN132-015	1-1/2	200
LN132-020	2	150
LN132-030	3	35
LN132-040	4	40
LN132-060	6	10

90° STREET ELBOW (HUB x SPG)

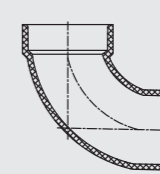

Part Number	Size (in)	Std PK
LN302-012	1-1/4	75
LN302-015	1-1/2	45
LN302-020	2	25
LN302-030	3	15
LN302-040	4	15
LN302-060	6	3

THREADED CAP (FIPT)

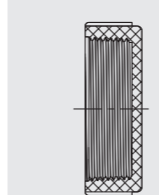

Part Number	Size (in)	Std PK
LN135-015	1-1/2	100
LN135-020	2	125
LN135-030	3	50

90° STREET ELBOW-SHORT TURN (HUB x SPG)

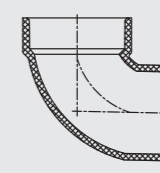

Part Number	Size (in)	Std PK
LN302-015S	1-1/2	125
LN302-020S	2	50
LN302-030S	3	20
LN302-040S	4	20

ABS DWV Fittings



90° ELBOW W/LOW HEEL INLET (HUB x HUB x HUB)

Part Number	Size (in)	Std PK
LN303-337	3x3x1-1/2	25
LN303-338	3x3x2	15
LN303-420	4x4x2	10

90° LONG SWEEP ELBOW (HUB x HUB)

Part Number	Size (in)	Std PK
LN304-012	1-1/4	50
LN304-015	1-1/2	50
LN304-020	2	25
LN304-030	3	10
LN304-040	4	10

90° STREET ELBOW W/ LOW HEEL INLET (HUB x SPG x HUB)

Part Number	Size (in)	Std PK
LN310-338	3x3x2	10

60° ELBOW (HUB x HUB)

Part Number	Size (in)	Std PK
LN319-015	1-1/2	60
LN319-020	2	40
LN319-030	3	20
LN319-040	4	10

60° STREET ELBOW (HUB x SPG)

Part Number	Size (in)	Std PK
LN320-015	1-1/2	50
LN320-020	2	25
LN320-030	3	20
LN320-040	4	10

45° ELBOW (HUB x HUB)

Part Number	Size (in)	Std PK
LN321-012	1-1/4	100
LN321-015	1-1/2	100
LN321-020L	2	50
LN321-030L	3	20
LN321-040	4	10
LN321-060	6	8

45° ELBOW-SHORT TURN (HUB x HUB)

Part Number	Size (in)	Std PK
LN321-015S	1-1/2	125
LN321-020S	2	50
LN321-030S	3	25
LN321-040S	4	25

45° STREET ELBOW (HUB x SPG)

Part Number	Size (in)	Std PK
LN323-012	1-1/4	40
LN323-015	1-1/2	100
LN323-020L	2	50
LN323-030L	3	20
LN323-040	4	10
LN323-060	6	5

45° STREET ELBOW-SHORT TURN (HUB x SPG)

Part Number	Size (in)	Std PK
LN323-015S	1-1/2	125
LN323-020S	2	50
LN323-030S	3	25
LN323-040S	4	25

22 1/2° ELBOW (HUB x HUB)

Part Number	Size (in)	Std PK
LN324-015	1-1/2	75
LN324-020	2	50
LN324-030	3	20
LN324-040	4	15
LN324-060	6	5

ABS DWV Fittings



22 1/2° STREET ELBOW (HUB x SPG)

Part Number	Size (in)	Std PK
LN326-015	1-1/2	50
LN326-020	2	50
LN326-030	3	20
LN326-040	4	10

DOUBLE 90° ELBOW (HUB x HUB x HUB)

Part Number	Size (in)	Std PK
LN327-015	1-1/2	25
LN327-020	2	20
LN327-030	3	5
LN327-040	4	10
LN327-241	2x1-1/2x1-1/2	25

90° REDUCING CLOSET ELBOW (HUB x HUB)

Part Number	Size (in)	Std PK
LN329-422	4x3	20

90° REDUCING CLOSET STREET ELBOW (HUB x SPG)

Part Number	Size (in)	Std PK
LN330-342	3x4	10

90° REDUCING CLOSET STREET ELBOW W/ TEST CAP (HUB x SPG)

Part Number	Size (in)	Std PK
LN330X-342	3x4	10

VENT ELL (HUB x HUB)

Part Number	Size (in)	Std PK
LN331-012	1-1/4	100
LN331-015	1-1/2	50
LN331-020	2	25
LN331-030	3	20
LN331-040	4	15

SANITARY TEE (HUB x HUB x HUB)

Part Number	Size (in)	Std PK
LN400-012L	1-1/4	50
LN400-015L	1-1/2	100
LN400-020L	2	35
LN400-030	3	20
LN400-040L	4	10
LN400-060	6	3

REDUCING SANITARY TEE (HUB x HUB x HUB)

Part Number	Size (in)	Std PK
LN401-212	1-1/2x1-1/2x1-1/4	50
LN401-222	1-1/2x1-1/4x1-1/4	50
LN401-225	1-1/2x1-1/4x1-1/2	50
LN401-241L	2x1-1/2x1-1/2	25
LN401-251L	2x2x1-1/2	50
LN401-257L	2x1-1/2x2	50
LN401-337	3x3x1-1/2	25
LN401-338L	3x3x2	20
LN401-419	4x4x1-1/2	15
LN401-420	4x4x2	20
LN401-422	4x4x3	15
LN401-532	6x6x4	5

STREET SANITARY TEE (SPG x HUB x HUB)

Part Number	Size (in)	Std PK
LN403-015	1-1/2	50
LN403-020	2	20
LN403-030	3	20
LN403-040	4	10

ABS DWV Fittings



REDUCING STREET SANITARY TEE (SPG x HUB x HUB)

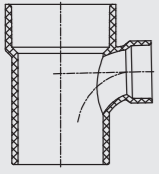

Part Number	Size (in)	Std PK
LN404-241	2x1-1/2x1-1/2	20
LN404-251	2x2x1-1/2	20
LN404-257	2x1-1/2x2	25
LN404-337	3x3x1-1/2	25
LN404-338	3x3x2	20

DOUBLE SANITARY TEE (ALL HUB)

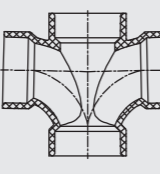

Part Number	Size (in)	Std PK
LN428-015	1-1/2	15
LN428-020	2	15
LN428-030	3	15
LN428-040	4	6

SANITARY TEE W/LEFT SIDE INLET (ALL HUB)

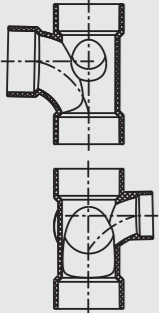

Part Number	Size (in)	Std PK
LN416-329	3x3x2x2	10
LN416-337	3x3x3x1-1/2	10
LN416-338	3x3x3x2	10
LN416-420	4x4x4x2	5

REDUCING DOUBLE SANITARY TEE (ALL HUB)

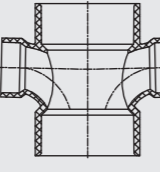

Part Number	Size (in)	Std PK
LN429-251	2x2x1-1/2x1-1/2	20
LN429-323	3x3x2x1-1/2	20
LN429-337	3x3x1-1/2x1-1/2	15
LN429-338	3x3x2x2	8
LN429-420	4x4x2x2	5
LN429-422	4x4x3x3	10

SANITARY TEE W/RIGHT SIDE INLET (ALL HUB)

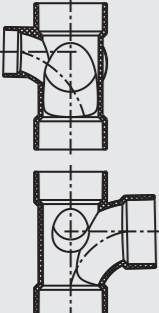

Part Number	Size (in)	Std PK
LN417-329	3x3x2x2	5
LN417-337	3x3x3x1-1/2	10
LN417-338	3x3x3x2	10
LN417-420	4x4x4x2	5

DOUBLE SANITARY TEE W /SIDE INLET (ALL HUB)

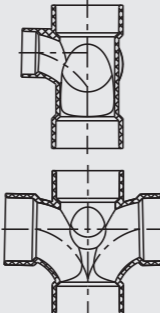

Part Number	Size (in)	Std PK
LN438-337	3x3x3x3x1-1/2	10
LN438-338	3x3x3x3x2	10
LN438-420	4x4x4x4x2	5

SANITARY TEE W/R&L SIDE INLETS (ALL HUB)

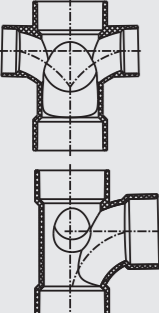

Part Number	Size (in)	Std PK
LN418-337	3x3x3x1-1/2x1-1/2	
LN418-338	3x3x3x2x2	10
LN418-420	4x4x4x2x2	5

DOUBLE SANITARY TEE W/R&L SIDE INLET (ALL HUB)

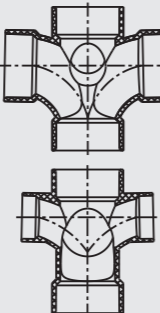

Part Number	Size (in)	Std PK
LN439-338	3x3x3x3x2x2	10

ABS DWV Fittings



VENT TEE (HUB x HUB x HUB)

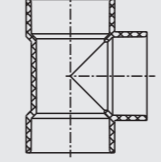

Part Number	Size (in)	Std PK
LN441-015	1-1/2	50
LN441-020	2	20
LN441-030	3	10
LN441-040	4	15

DOUBLE FIXTURE FITTING (ALL HUB)

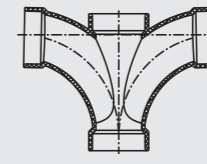

Part Number	Size (in)	Std PK
LN500-020	2	25
LN500-030	3	10
LN500-241	2x1-1/2x1-1/2x1-1/2	20
LN500-257	2x1-1/2x2x2	25
LN500-338	3x2x3x3	10

REDUCING VENT TEE (HUB x HUB x HUB)

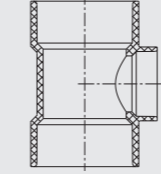

Part Number	Size (in)	Std PK
LN441-337	3x3x1-1/2	35
LN441-338	3x3x2	35

COMBINATION WYE & 1/8 BEND (ONE PIECE) (HUB x HUB x HUB)

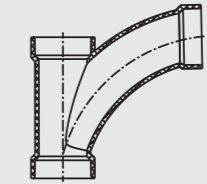

Part Number	Size (in)	Std PK
LN501-015	1-1/2	20
LN501-020	2	25
LN501-030	3	10
LN501-040	4	6

TEST TEE (HUB x HUB x CLEANOUT W/PLUG)

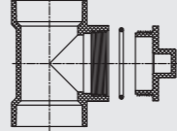

Part Number	Size (in)	Std PK
LN444X-015L	1-1/2	50
LN444X-020L	2	50
LN444X-030L	3	10
LN444X-040L	4	10
LN444X-427	4x3x4	15

REDUCING COMBINATION WYE & 1/8 BEND (ONE PIECE) (HUB x HUB x HUB)

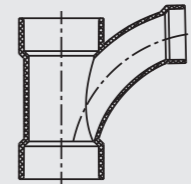

Part Number	Size (in)	Std PK
LN502-241	2x1-1/2x1-1/2	20
LN502-251	2x2x1-1/2	20
LN502-257	2x1-1/2x2	24
LN502-337	3x3x1-1/2	20
LN502-338	3x3x2	10
LN502-420	4x4x2	10
LN502-422	4x4x3	5

TEST TEE (HUB x HUB x FIPT)

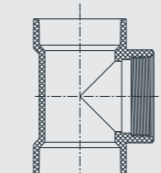

Part Number	Size (in)	Std PK
LN445-015L	1-1/2	55
LN445-020L	2	50
LN445-030L	3	25
LN445-040L	4	15

COMBINATION WYE & 1/8 BEND (TWO PIECE) (HUB x HUB x HUB)

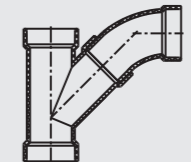

Part Number	Size (in)	Std PK
LN503-020	2	20

TWO-WAY CLEANOUT (HUB x HUB x HUB)

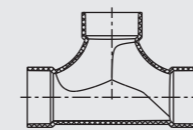

Part Number	Size (in)	Std PK
LN448-030	3	10
LN448-040	4	5

ABS DWV Fittings



45° WYE (HUB x HUB x HUB)

Part Number	Size (in)	Std PK
LN600-012	1-1/4	50
LN600-015L	1-1/2	50
LN600-020L	2	25
LN600-030L	3	15
LN600-040L	4	10
LN600-060	6	2

45° REDUCING WYE (HUB x HUB x HUB)

Part Number	Size (in)	Std PK
LN601-241	2x1-1/2x1-1/2	25
LN601-251L	2x2x1-1/2	50
LN601-337L	3x3x1-1/2	20
LN601-338L	3x3x2	20
LN601-419	4x4x1-1/2	20
LN601-420L	4x4x2	10
LN601-422L	4x4x3	10
LN601-530	6x6x3	5
LN601-532	6x6x4	4

DISHWASHER Y (HUB)

Part Number	Size (in)	Std PK
LN601-209	1-1/2" x 1-1/2" x 1/2"	34
LN601-210	1-1/2" x 1-1/2" x 3/4"	34

45° STREET WYE (SPG x HUB x HUB)

Part Number	Size (in)	Std PK
LN602-015	1-1/2	125
LN602-020	2	15
LN602-030	3	20
LN602-040	4	5

45° REDUCING STREET WYE (SPG x HUB x HUB)

Part Number	Size (in)	Std PK
LN603-337	3x3x1-1/2	10
LN603-338	3x3x2	25
LN603-422	4x4x3	10

CLEANOUT WYE (HUB x HUB x FIPT)

Part Number	Size (in)	Std PK
LN604-015	1-1/2	50

DISHWASHER ADAPTER (SP x BARB)

Part Number	Size (in)	Std PK
LN610-015	1-1/2	70

45° DOUBLE WYE (ALL HUB)

Part Number	Size (in)	Std PK
LN611-015	1-1/2	30
LN611-020	2	20
LN611-030L	3	5
LN611-040	4	5

45° REDUCING DOUBLE WYE (ALL HUB)

Part Number	Size (in)	Std PK
LN612-251	2x2x1-1/2x1-1/2	20
LN612-337	3x3x1-1/2x1-1/2	15
LN612-338	3x3x2x2	15
LN612-420	4x4x2x2	10
LN612-422	4x4x3x3	5
LN612-532	6x6x4x4	3

RETURN BEND (HUB x HUB)

Part Number	Size (in)	Std PK
LN700-015	1-1/2	
LN700-020	2	
LN700-030	3	
LN700-040	4	

ABS DWV Fittings



P-TRAP (HUB x HUB)

Part Number	Size (in)	Std PK
LN706X-015	1-1/2	40
LN706X-020	2	20
LN706X-030	3	10
LN706X-040	4	6

P-TRAP W/PLUG (HUB x HUB x CLEANOUT W/PLUG)

Part Number	Size (in)	Std PK
LN707X-015	1-1/2	35
LN707X-020	2	20

P-TRAP W/UNION JOINT (HUB x HUB)

Part Number	Size (in)	Std PK
LN708P-012	1-1/4	40
LN708P-015	1-1/2	40
LN708P-020	2	20

LA PATTERN P-TRAP W/UNION & PLASTIC NUT (HUB x SJ)

Part Number	Size (in)	Std PK
LN711M-015	1-1/2	50

P-TRAP W/UNION & C/O (HUB x HUB x C/O)

Part Number	Size (in)	Std PK
LN712-015	1-1/2	35

CLOSET FLANGE (HUB)

Part Number	Size (in)	Std PK
LN800-422L	4x3	25
LN800-040	4x4	25

CLOSET FLANGE W/KNOCKOUT TEST PLUG (HUB)

Part Number	Size (in)	Std PK
LN800T-422L	4x3	25
LN800T-040	4x4	

CLOSET FLANGE W/ THREADED TEST PLUG (HUB)

Part Number	Size (in)	Std PK
LN800T-422CL	4x3	25
LN800T-040C	4x4	25

REDUCING CLOSET FLANGE (SPG)

Part Number	Size (in)	Std PK
LN801-422	4x3	25

CLOSET FLANGE W/ADJUSTABLE PLASTIC RING (HUB)

Part Number	Size (in)	Std PK
LN810P-040	4x4	25

ABS DWV Fittings



CLOSET FLANGE W/ADJUSTABLE PLASTIC RING (HUB)

Part Number	Size (in)	Std PK
LN810P-422	4x3	

CLOSET FLANGE (FIPT)

Part Number	Size (in)	Std PK
LN830-422	4x3	25

CLOSET FLANGE W/ADJUSTABLE PLASTIC RING (SPG)

Part Number	Size (in)	Std PK
LN812P-422	4x3	25

CLOSET FLANGE (MIPT)

Part Number	Size (in)	Std PK
LN831-422	4x3	10

CLOSET FLANGE , ABS-3" INSIDE FIT

Part Number	Size (in)	Std PK
LN813-422	4x3	

EXPANSION JOINT (HUB x HUB)

Part Number	Size (in)	Std PK
LNH119-015	1-1/2	12
LNH119-020	2	15
LNH119-030	3	15
LNH119-040	4	4

ADJUSTABLE OFFSET FLANGE (HUB)

Part Number	Size (in)	Std PK
LN820-422	4x3	15

EXPANSION JOINT (HUB x SPG)

Part Number	Size (in)	Std PK
LNH119S-030	3	15

FIPT: Female Iron Pipe Thread
 MIPT: Male Iron Pipe Thread
 Spg: Spigot
 SJ: Slip Joint
 W/: with

Note:
 Part of items isn't listed in CSA or NSF or UPC temporarily

AMERICAN CERTIFICATIONS

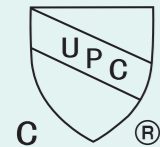

IAPMO RESEARCH AND TESTING, INC.
5001 East Philadelphia Street, Ontario, California 91761-2816 - USA • 909-472-4100 • 909-472-4244 • www.iapmo.org

ANSI IAPMO R&T

CERTIFICATE OF LISTING

The most updated information on this Certificate of Listing is available online at pld.iapmo.org

Effective Date: December 2018 Void After: December 2019

Product: POLY VINYL CHLORIDE (PVC) Plastic Pipe Fittings, Schedule 40 File No. 7331

Issued To: Guangdong Liansu Technology Industrial Co., Ltd
Liansu Industrial Estate
Longjiang Town, Shunde Zone
Foshan, GUANGDONG 528318
China

Identification: Fittings shall be marked permanently and legibly with manufacturer's name or trademark, material designation (PVC I for PVC 12454-B, PVC II for PVC 12454-C, PVC 13 for PVC 13354-C and 1443-B, and PVC II for PVC 14333-D), size, "D2466," "B137.3" and the UPC[®] certification mark. Fittings intended for contact with potable water shall bear the mark or the seal of the laboratory making the evaluation for potable water contact as well as the word "potable" or the designation "P" or "PW". Note: Where the size of the fitting does not allow complete marking, omit identification marking in the following sequence: size, material designation, manufacturer's name or trademark. Where recessed marking is used, care shall be taken to see that in no case marking causes cracks or reduces the wall thickness below the minimum specified.

Characteristics: Poly vinyl chloride (PVC) schedule 40 pipe fittings for use only with the distribution of pressurized liquids, which are chemically compatible with the piping materials. Note: Due to inherent hazards

Tim Collings
Chairman, Product Certification Committee

Ran Chang
CEO, The IAPMO Group

This listing is based upon the test data of the tests indicated on the Effective Date and Void After Date shown above. Any change in material, manufacturing process, marking or design without having first obtained the approval of the Product Certification Committee, or any evidence of non-compliance with applicable codes and standards, or of inferior workmanship, may be deemed sufficient cause for revocation of this listing. Persistence of reference to this listing for marketing purposes may be made only by specific written permission of IAPMO Research and Testing, Inc. Any alteration of this certificate could be grounds for revocation of the listing. This document shall be reproduced in its entirety.



NSF International

OFFICIAL LISTING

NSF certifies that the products appearing on this Listing conform to the requirements of NSF/ANSI Standard 14 - Flexible Piping System Components and Related Materials. This is the Official Listing recorded on March 26, 2019.

Guangdong Liansu Technology Industrial Co., Ltd DBA Lesso America, Inc.
Liansu Industrial Estate
Longjiang Town, Shunde Zone
Foshan, Guangdong 528318
China
86 757 2388 8337

Facility: # 2 China

Product Type	Material Type	Trade Name	Product Standard
20 1/2" Elbow (DN6 x DN6)	ABS	Lesso	ASTM D2467
1/2" Elbow (1/2" x 1/2")	ABS		ASTM D2467
3/4" Elbow (3/4" x 3/4")	ABS		ASTM D2467
1" Elbow (1" x 1")	ABS		ASTM D2467
1 1/2" Elbow (1 1/2" x 1 1/2")	ABS		ASTM D2467
2" Elbow (2" x 2")	ABS		ASTM D2467
2 1/2" Elbow (2 1/2" x 2 1/2")	ABS		ASTM D2467
3" Elbow (3" x 3")	ABS		ASTM D2467
3 1/2" Elbow (3 1/2" x 3 1/2")	ABS		ASTM D2467
4" Elbow (4" x 4")	ABS		ASTM D2467
4 1/2" Elbow (4 1/2" x 4 1/2")	ABS		ASTM D2467
5" Elbow (5" x 5")	ABS		ASTM D2467
5 1/2" Elbow (5 1/2" x 5 1/2")	ABS		ASTM D2467
6" Elbow (6" x 6")	ABS		ASTM D2467
6 1/2" Elbow (6 1/2" x 6 1/2")	ABS		ASTM D2467
7" Elbow (7" x 7")	ABS		ASTM D2467
7 1/2" Elbow (7 1/2" x 7 1/2")	ABS		ASTM D2467
8" Elbow (8" x 8")	ABS		ASTM D2467
8 1/2" Elbow (8 1/2" x 8 1/2")	ABS		ASTM D2467
9" Elbow (9" x 9")	ABS		ASTM D2467
9 1/2" Elbow (9 1/2" x 9 1/2")	ABS		ASTM D2467
10" Elbow (10" x 10")	ABS		ASTM D2467
10 1/2" Elbow (10 1/2" x 10 1/2")	ABS		ASTM D2467
11" Elbow (11" x 11")	ABS		ASTM D2467
11 1/2" Elbow (11 1/2" x 11 1/2")	ABS		ASTM D2467
12" Elbow (12" x 12")	ABS		ASTM D2467
12 1/2" Elbow (12 1/2" x 12 1/2")	ABS		ASTM D2467
13" Elbow (13" x 13")	ABS		ASTM D2467
13 1/2" Elbow (13 1/2" x 13 1/2")	ABS		ASTM D2467
14" Elbow (14" x 14")	ABS		ASTM D2467
14 1/2" Elbow (14 1/2" x 14 1/2")	ABS		ASTM D2467
15" Elbow (15" x 15")	ABS		ASTM D2467
15 1/2" Elbow (15 1/2" x 15 1/2")	ABS		ASTM D2467
16" Elbow (16" x 16")	ABS		ASTM D2467
16 1/2" Elbow (16 1/2" x 16 1/2")	ABS		ASTM D2467
17" Elbow (17" x 17")	ABS		ASTM D2467
17 1/2" Elbow (17 1/2" x 17 1/2")	ABS		ASTM D2467
18" Elbow (18" x 18")	ABS		ASTM D2467
18 1/2" Elbow (18 1/2" x 18 1/2")	ABS		ASTM D2467
19" Elbow (19" x 19")	ABS		ASTM D2467
19 1/2" Elbow (19 1/2" x 19 1/2")	ABS		ASTM D2467
20" Elbow (20" x 20")	ABS		ASTM D2467
20 1/2" Elbow (20 1/2" x 20 1/2")	ABS		ASTM D2467

Note: Additions shall not be made to this document without prior evaluation and acceptance by NSF International.

800 N. Dixboro Road, Ann Arbor, Michigan 48106-0121 USA
1-800-NSF-NSF, 734-769-8818
www.nsf.org

IAPMO RESEARCH AND TESTING, INC.
5001 East Philadelphia Street, Ontario, California 91761-2816 - USA • 909-472-4100 • 909-472-4244 • www.iapmo.org

ANSI IAPMO R&T

CERTIFICATE OF LISTING

The most updated information on this Certificate of Listing is available online at pld.iapmo.org

Effective Date: July 2018 Void After: July 2019

Product: PVC-DWV Fittings File No. 9267

Issued To: Guangdong Liansu Technology Industrial Co Ltd
Liansu Industrial Estate
Longjiang Town
Shunde Zone
Foshan, GD 528318
China

Identification: Fittings shall be marked on the body or hub with the manufacturer's name or trademark, or both, the symbol "PVC" and the UPC[®] certification mark. Fittings shall also be marked with the CSA Standard Designation CSA B181.1 however, it may be replaced with the legend "DWV". Fittings may also be marked with the nominal size. Markings on fittings shall be permanent or indelible in legible letters and numerals and of a color that contrasts with the color of the fitting when printed markings are used. Markings solid to the exterior surface, preferably on the body or the hub, or a permanent stick-on label shall be acceptable. Markings on fabricated fittings shall include a description of the fitting configuration (e.g., 90° elbow, 45° wye) and be marked with the following: "FABRICATED FITTING" or "FAB FTG"

Characteristics: These fittings are made from polyvinyl chloride (PVC) compound manufactured to ASTM specifications. They are gray, ivory or white in color and are to be used with IAPMO listed pipe, primers and solvent cements. Installation shall comply with the requirements of the latest

Tim Collings
Chairman, Product Certification Committee

Ran Chang
CEO, The IAPMO Group

This listing is based upon the test data of the tests indicated on the Effective Date and Void After Date shown above. Any change in material, manufacturing process, marking or design without having first obtained the approval of the Product Certification Committee, or any evidence of non-compliance with applicable codes and standards, or of inferior workmanship, may be deemed sufficient cause for revocation of this listing. Persistence of reference to this listing for marketing purposes may be made only by specific written permission of IAPMO Research and Testing, Inc. Any alteration of this certificate could be grounds for revocation of the listing. This document shall be reproduced in its entirety.

IAPMO RESEARCH AND TESTING, INC.
5001 East Philadelphia Street, Ontario, California 91761-2816 - USA • 909-472-4100 • 909-472-4244 • www.iapmo.org

ANSI IAPMO R&T

CERTIFICATE OF LISTING

The most updated information on this Certificate of Listing is available online at pld.iapmo.org

Effective Date: July 2018 Void After: July 2019

Product: ABS-DWV Pipe and Fittings File No. 9266

Issued To: Guangdong Liansu Technology Industrial Co Ltd
Liansu Industrial Estate
Longjiang Town
Shunde Zone
Foshan, GD 528318
China

Identification: The pipe shall be marked on two sides 180° apart or spirally in letters not less than 3/16" high in a contrasting color and shall consist of the manufacturer's name or trademark, nominal pipe size, "ABS DWV" for pipe produced by single extrusion process, "COEX ABS DWV" for pipe produced by the coextrusion process, "ASTM D2467", the date of manufacture or date coding, the designation "B181.1" and the UPC[®] certification mark, spaced at intervals of not more than 2 ft. Fittings shall be marked on the body or hub with manufacturer's name or trademark, or both, "ABS", "B181.1", and the UPC[®] certification mark.

Characteristics: Single and coextruded layers of Acrylonitrile-Butadiene-Styrene (ABS) plastic drains, waste and vent (DWV) pipe and fittings made to schedule 40 iron pipe size (IPS). To be installed in accordance with the manufacturer's instructions and the requirements of the latest editions of the Uniform Plumbing Code.

Tim Collings
Chairman, Product Certification Committee

Ran Chang
CEO, The IAPMO Group

This listing is based upon the test data of the tests indicated on the Effective Date and Void After Date shown above. Any change in material, manufacturing process, marking or design without having first obtained the approval of the Product Certification Committee, or any evidence of non-compliance with applicable codes and standards, or of inferior workmanship, may be deemed sufficient cause for revocation of this listing. Persistence of reference to this listing for marketing purposes may be made only by specific written permission of IAPMO Research and Testing, Inc. Any alteration of this certificate could be grounds for revocation of the listing. This document shall be reproduced in its entirety.

NSF International
789 N. Dixboro Road, Ann Arbor, MI 48105 USA

REFERENCE CERTIFICATE

Guangdong Liansu Technology Industrial Co., Ltd DBA Lesso America, Inc.
Facility: Corona, CA

COMPLIES WITH NSF/ANSI 14 AND THE FOLLOWING REFERENCE STANDARDS. PRODUCTS APPEARING IN THE NSF OFFICIAL LISTING ARE AUTHORIZED TO BEAR THE NSF MARK.

- ASTM D2466
- ASTM D2467
- ASTM D2661
- ASTM D2665
- CSA B137.3
- CSA B181.1
- CSA B181.2
- SE 7992
- NSF/ANSI 61
- Uniform Plumbing CodeTM

David Parkin
Vice President, Water Systems

Issue Date: March 8, 2019
Certificate Valid Through: March 8, 2020
Certificate # C0214560-01R

This certificate is supplemental to the NSF Certification Certificate and does not replace the NSF Certification Certificate. This certificate is the property of NSF International and must be returned upon request. For the most current and complete Listing information, please access NSF's website (www.nsf.org).

NSF International
789 N. Dixboro Road, Ann Arbor, MI 48105 USA

REFERENCE CERTIFICATE

Guangdong Liansu Technology Industrial Co., Ltd DBA Lesso America, Inc.
Facility: # 2 China

COMPLIES WITH NSF/ANSI 14 AND THE FOLLOWING REFERENCE STANDARDS. PRODUCTS APPEARING IN THE NSF OFFICIAL LISTING ARE AUTHORIZED TO BEAR THE NSF MARK.

- ASTM F1970
- ASTM D2466
- ASTM D2467
- ASTM D2661
- ASTM D2665
- CSA B137.3
- CSA B181.1
- CSA B181.2
- SE 7992
- NSF/ANSI 61
- NSF/ANSI 61, Annex G
- Uniform Plumbing CodeTM

David Parkin
Vice President, Water Systems

Issue Date: March 8, 2019
Certificate Valid Through: March 8, 2020
Certificate # C0075891-03R

This certificate is supplemental to the NSF Certification Certificate and does not replace the NSF Certification Certificate. This certificate is the property of NSF International and must be returned upon request. For the most current and complete Listing information, please access NSF's website (www.nsf.org).

AMERICAN CERTIFICATIONS



Certificate of Compliance

Certificate: 2685332 Master Contract: 253541 (253541)
 Project: 70190494 Date Issued: 2018-07-25

Issued to: Guangdong Liansu Technology Industrial Co. Ltd.
 Liansu Industrial Estate
 Longjiang Town
 Shunde Zone
 Foshan City, Guangdong, 528318
 CHINA
 Attention: Jane Chen

The products listed below are eligible to bear the CSA Mark shown with adjacent indicators 'C' and 'US' for Canada and US or with adjacent indicator 'US' for US only or without either indicator for Canada only.

Issued by: *Grazyna Blazejewska*
Grazyna Blazejewska

PRODUCTS

CLASS - C763201 - PLASTIC PIPE-Drain Waste and Vent Fittings

CLASS - C763281 - PLASTIC NON-PRESSURE PIPE-Drain Waste and Vent Fittings - Certified to US Standards

ABS FITTINGS

Product Description	Model No.1	Model No.2	Model No.3
COUPLING (HUB - HUB)	LN100-012	RLN100-012	CPRLN100-012
	LN100-015	RLN100-015	CPRLN100-015
	LN100-020	RLN100-020	CPRLN100-020
	LN100-030	RLN100-030	CPRLN100-030
	LN100-040	RLN100-040	CPRLN100-040
	LN100-060	RLN100-060	CPRLN100-060
FEMALE ADAPTER(HUB-FIPT)	LN101-012	RLN101-012	CPRLN101-012
	LN101-015	RLN101-015	CPRLN101-015

D000-107 Rev. 2016-02-18 Page 1

Certificate: 2685332 Master Contract: 253541
 Project: 70190494 Date Issued: 2018-07-25

Product Description	Model No.1	Model No.2	Model No.3
PIPE INCREASER-REDUCER(HUB/HUB)	LN101-020	RLN101-020	CPRLN101-020
	LN101-030	RLN101-030	CPRLN101-030
	LN101-040	RLN101-040	CPRLN101-040
	LN101-060	RLN101-060	CPRLN101-060
	LN102-212	RLN102-212	CPRLN102-212
	LN102-251	RLN102-251	CPRLN102-251
	LN102-337	RLN102-337	CPRLN102-337
	LN102-338	RLN102-338	CPRLN102-338
	LN102-419	RLN102-419	CPRLN102-419
	LN102-420	RLN102-420	CPRLN102-420
	LN102-420L	RLN102-420L	CPRLN102-420L
	LN102-422	RLN102-422	CPRLN102-422
TRAP ADAPTER (SPG-SF)	LN103-012	RLN103-012	CPRLN103-012
	LN103-212	RLN103-212	CPRLN103-212
	LN103-015	RLN103-015	CPRLN103-015
	LN103-020	RLN103-020	CPRLN103-020
TRAP ADAPTER W/CHROME NUT & WASHER(SPG-SF)	LN103W-015	RLN103W-015	CPRLN103W-015
	LN103W-020	RLN103W-020	CPRLN103W-020
TRAP ADAPTER W/PLASTIC NUT(SPG-SF)	LN103P-012	RLN103P-012	CPRLN103P-012
	LN103P-015	RLN103P-015	CPRLN103P-015
TRAP ADAPTER W/ PLASTIC NUT & WASHER(SPG-SF)	LN103X-012	RLN103X-012	CPRLN103X-012
	LN103X-015	RLN103X-015	CPRLN103X-015
	LN103X-020	RLN103X-020	CPRLN103X-020
	LN103X-212	RLN103X-212	CPRLN103X-212
	LN104W-020	RLN104W-020	CPRLN104W-020
	LN104W-212	RLN104W-212	CPRLN104W-212
TRAP ADAPTER (HUB-SF)	LN104-012	RLN104-012	CPRLN104-012
	LN104-015	RLN104-015	CPRLN104-015

D000-107 Rev. 2016-02-18 Page 2

Certificate: 2685332 Master Contract: 253541
 Project: 70190494 Date Issued: 2018-07-25

Product Description	Model No.1	Model No.2	Model No.3
TRAP ADAPTER W/PLASTIC NUT(HUB-SF)	LN104P-012	RLN104P-012	CPRLN104P-012
	LN104P-015	RLN104P-015	CPRLN104P-015
	LN104P-212	RLN104P-212	CPRLN104P-212
TRAP ADAPTER W/ PLASTIC NUT & WASHER(HUB-SF)	LN104X-012	RLN104X-012	CPRLN104X-012
	LN104X-015	RLN104X-015	CPRLN104X-015
	LN104X-020	RLN104X-020	CPRLN104X-020
	LN104X-212	RLN104X-212	CPRLN104X-212
CLEANOUT ADAPTER (SPG-FIPT)	LN105-012	RLN105-012	CPRLN105-012
	LN105-015	RLN105-015	CPRLN105-015
	LN105-020	RLN105-020	CPRLN105-020
	LN105-030	RLN105-030	CPRLN105-030
	LN105-040	RLN105-040	CPRLN105-040
	LN105-060	RLN105-060	CPRLN105-060
CLEANOUT ADAPTER W/PLUG(SPG-CLEANOUT W/PLUG)	LN105X-012	RLN105X-012	CPRLN105X-012
	LN105X-015	RLN105X-015	CPRLN105X-015
	LN105X-020	RLN105X-020	CPRLN105X-020
	LN105X-030	RLN105X-030	CPRLN105X-030
CLEANOUT PLUG(MIPT)	LN106-015	RLN106-015	CPRLN106-015
	LN106-020	RLN106-020	CPRLN106-020
	LN106-025	RLN106-025	CPRLN106-025
	LN106-030	RLN106-030	CPRLN106-030
	LN106-035	RLN106-035	CPRLN106-035
	LN106-040	RLN106-040	CPRLN106-040
PLUG WITH GASKET(MIPT)	LN106R-012	RLN106R-012	CPRLN106R-012
	LN106R-015	RLN106R-015	CPRLN106R-015
	LN106R-020	RLN106R-020	CPRLN106R-020
	LN106R-025	RLN106R-025	CPRLN106R-025
	LN106R-030	RLN106R-030	CPRLN106R-030

D000-107 Rev. 2016-02-18 Page 3

Certificate: 2685332 Master Contract: 253541
 Project: 70190494 Date Issued: 2018-07-25

Product Description	Model No.1	Model No.2	Model No.3
FLUSH BUSHING (SPG-HUB)	LN106R-040	RLN106R-040	CPRLN106R-040
	LN106R-060	RLN106R-060	CPRLN106R-060
	LN107-212	RLN107-212	CPRLN107-212
	LN107-251	RLN107-251	CPRLN107-251
	LN107-337	RLN107-337	CPRLN107-337
	LN107-338	RLN107-338	CPRLN107-338
FLUSH ADAPTER (SPG-FIPT)	LN107-419	RLN107-419	CPRLN107-419
	LN107-420	RLN107-420	CPRLN107-420
	LN107-422	RLN107-422	CPRLN107-422
	LN107-532	RLN107-532	CPRLN107-532
	LN108-209	RLN108-209	CPRLN108-209
	LN108-210	RLN108-210	CPRLN108-210
MALE ADAPTER(HUB-MIPT)	LN108-212	RLN108-212	CPRLN108-212
	LN108-251	RLN108-251	CPRLN108-251
	LN108-337	RLN108-337	CPRLN108-337
	LN108-338	RLN108-338	CPRLN108-338
SLIP PLUG (SPG)	LN108-422	RLN108-422	CPRLN108-422
	LN109-012	RLN109-012	CPRLN109-012
	LN109-212	RLN109-212	CPRLN109-212
	LN109-015	RLN109-015	CPRLN109-015
	LN109-020	RLN109-020	CPRLN109-020
	LN109-030	RLN109-030	CPRLN109-030
MALE ADAPTER(SPG-MIPT)	LN109-040	RLN109-040	CPRLN109-040
	LN1105-015	RLN1105-015	CPRLN1105-015
	LN1105-020	RLN1105-020	CPRLN1105-020
	LN1105-025	RLN1105-025	CPRLN1105-025
MALE ADAPTER(SPG-MIPT)	LN1105-030	RLN1105-030	CPRLN1105-030
	LN1105-035	RLN1105-035	CPRLN1105-035
	LN1105-040	RLN1105-040	CPRLN1105-040
	LN111-012	RLN111-012	CPRLN111-012

D000-107 Rev. 2016-02-18 Page 4

Limited Warranty

Except as otherwise mandated by law, LESSO America warrants to Buyer only that the Products directly manufactured by LESSO America will be free from defects in material and workmanship for a period of three years from the date of installation. Buyer agrees that this warranty shall be effective so long as the Products are used solely for the normal purposes for which they are intended and in conformity with industry established engineering, installation, operating, and maintenance specifications, recommendations and instructions. Violation thereof shall void this warranty and relieve LESSO America from any obligation under this warranty.

LESSO America may modify at any time design of products or materials used therein or discontinue their manufacture without any liability.

LESSO America shall not assume responsibility, and expressly disclaims any liability, due to Buyer's, any installer's or end user's failure to comply with such specifications, recommendations and instructions, including, but not limited to, damage due to improper control of system hydraulics, improper winterization procedures, improper voltage supply, contact with incompatible materials or chemicals, excavation/digging, excessive weight, temperature shocking, U.V. degradation, vibration and vandalism. LESSO America shall not be liable for damages due to any acts of nature including, but not limited to, lightning, earthquakes, ground movement, frost heave, floods, or any other event of force majeure.

Buyer shall notify LESSO America of any alleged defects within 48 hours of discovery of any alleged defect and within three years' warranty period. LESSO America is not liable for any warranty claim if such notice is not provided. After the examination of the returned products, if the goods are determined to be defective in materials or workmanship directly provided by LESSO America, LESSO America will, at its sole option, may either repair or replace the defective Products, or reimburse Buyer for the cost of such Products. This shall be Buyer's only remedy. All costs of shipping such questionable Products and any replacements thereof to and from LESSO America's facility shall be borne by Buyer.

THIS LIMITED WARRANTY REPLACES ALL OTHER ORAL OR WRITTEN WARRANTIES, LIABILITIES OR OBLIGATIONS OF LESSO America. THIS WARRANTY MAY NOT BE EXTENDED, ALTERED OR OTHERWISE MODIFIED EXCEPT BY WRITTEN AGREEMENT SIGNED BY COMPANY. BY ITS ACCEPTANCE OF THE PRODUCTS, CUSTOMER HEREBY SPECIFICALLY AND EXPRESSLY WAIVES ALL OTHER LIABILITY OR OBLIGATION OF ANY KIND OR CHARACTER OF COMPANY, INCLUDING WITHOUT LIMITATION LIABILITY PREDICATED UPON STRICT LIABILITY OR TORT, AND ALL DAMAGES AND LOSSES AS A RESULT THEREOF, INCLUDING BUT NOT LIMITED TO ALL KNOWN, UNKNOWN, FORESEEABLE, UNFORESEEABLE, ABSOLUTE, CONTINGENT, LIQUIDATED, NON-LIQUIDATED, COMPENSATORY, GENERAL, SPECIAL, CONSEQUENTIAL, INCIDENTAL, OR PUNITIVE DAMAGES, AND WITH RESPECT TO THE PRODUCTS, THEIR RETURN, REPAIR, RESTORATION AND REPLACEMENT.

Buyer agrees that LESSO America will not be responsible for other parts or labor in connection with repairing, replacing, or returning such Products while Products are in possession of LESSO America for analysis, nor for any delays beyond LESSO America's reasonable control (including, with limitation, delays due to unavailability of materials, equipment, other supplies or labor, strikes, governmental regulation etc.), provided that any delay shall toll the warranty period for the same amount of time as the delay itself. In no event shall LESSO America be liable for consequential or incidental damages of any kind, including any damage to any property, building, its contents or any person therein, resulting from the breach of this warranty.

Terms and Conditions of Sale

1. General selling terms are 2% 30 net 45 days and free on board (FOB) Lesso America Warehouses.
2. Free freight allowance (FFA) will be provided on any order of \$1,800.00 or more for one shipment to a single destination within the contiguous United States.
3. Minimum order is \$150.00.
4. Returns will be accepted on purchases within 6 months only and must have prior authorization. They will be subject to a minimum of 20% restock fee. Customer is responsible for all shipping costs for the return. Returned items must be in full box and resaleable condition.
5. Any damages or shorted items need to be reported in writing within 15 days after product has been received.
6. Any cancellation for direct shipment must be notified in writing within 2 business days of receipt of purchase order with no fees incurred. If the cancellation is received after 2 business days, the customer shall be responsible for all related freight costs, insurance, customs duties, etc.
7. All pricing and terms are subject to change without prior notice.